



因联结而喜悦!!  
Delight Through Connections

# Industrial Relay



## 町洋企業股份有限公司

DINKLE ENTERPRISE CO.,LTD.  
臺灣新北市五股區五權二路19號 (新北產業園區)  
No.19,Wuquan 2nd Road., Wugu District,  
New Taipei City 24890, Taiwan  
TEL:+886-2-8069-9000 7705-6900  
FAX:+886-2-2290-1702 (代表號)  
E-mail:service@dinkle.com.tw  
Web site:http://www.dinkle.com

## 町洋國際股份有限公司

DINKLE INTERNATIONAL CO.,LTD.  
臺灣新北市五股區五權二路19號 (新北產業園區)  
No.19,Wuquan 2nd Road., Wugu District,  
New Taipei City 24890, Taiwan  
TEL:+886-2-8069-9000 7705-6900  
FAX:+886-2-2290-1702  
E-mail:service@dinkle.com.tw  
Web site:http://www.dinkle.com

## 奧迪克國際有限公司(香港)

OPTIKLE INTERNATIONAL CO., LTD.  
香港九龍九龍灣宏冠道6號 鴻力工業中心B座1樓29室  
Room 29, 1/F, Block B, Proficient Industrial Center,  
No.6 Wang Kwun Road,Kowloon Bay,Kowloon,  
HONG KONG.  
TEL:+852-2795-3840 2758-8005  
FAX:+852-2753-6919  
E-mail:service@dinkle.com.tw  
Web site:http://www.dinkle.com

## 町洋機電(中國)有限公司

DINKLE ELECTRIC MACHINERY(CHINA) CO.,LTD.  
江蘇省昆山市千燈鎮石浦工商管理區興浦中路258號 (215343)  
No.258,Xingpu Mid RD,Shipu Business Adminstrction Estate,  
Qiandeng Town,Kunshan City,Jiangsu Province,China  
TEL:+86-512-5708-8588  
FAX:+86-512-5708-8600  
E-mail:service@dinkle.com.tw  
Web site: http://www.dinkle.com

## 東莞立洋電機有限公司

LIYANG ELECTRIC MACHINERY(DONGGUAN) CO., LTD.  
廣東省東莞市黃江鎮鷄鳴崗村金錢嶺一街2號  
No.2 1st street Jinqian Ridge,Jiming gang village,  
Huangjiang town,Dongguan City,Guangdong Province  
TEL:+86-769-8336-4350 8336-4370  
FAX:+86-769-8384-8634  
E-mail:service@dinkle.com.tw  
Web site:http://www.dinkle.com

## 町洋電氣貿易(上海)有限公司

DINKLE ELECTRIC TRADING (SHANGHAI) CO.,LTD.  
上海市徐匯區漕溪北路18號上實大廈16層A室  
Room A, Floor 16, No.18 North Caoxi Road, Shanghai City  
TEL:+86-21-6487-0636 6427-3157  
FAX:+86-21-3356-2500  
E-mail:service@dinkle.com.tw  
Web site: http://www.dinkle.com

## 町洋美國分公司

DINKLE CORPORATION, USA  
12613 Executive Drive, Suite 704, Stafford, Texas 77477  
TEL:+832-539-4703  
Toll-Free:+844-273-1850  
FAX:+832-532-7226  
E-mail:service@dinkle.com.tw  
Web site: http://www.dinkle.com

## 町洋義大利分公司

DINKLE Italy  
(Budget Electronics S.e.l)  
Via Stabilini N° 14,  
23864 Malgrate (LC), Italia  
TEL:+39-0341-207161  
E-mail:service@dinkle.com.tw  
Web site: http://www.dinkle.com

### 北京辦事處

北京市海澱區知春路甲48號盈都大廈C座1單元5B  
TEL:+86-10-5873-4338  
FAX:+86-10-5873-4337

### 成都辦事處

四川省成都市天府新區華陽濱河路二段99號4-1-503  
TEL:+86-28-8736-5069  
FAX:+86-28-8736-5069

### 沈陽辦事處

遼寧省沈陽市和平區南京北街222號鑽石星座B座2113室  
TEL:+86-24-3107-8204  
FAX:+86-24-2486-9893

### 西安辦事處

陝西省西安市雁塔區科技路209號新西藍1-1-1705室  
TEL:+86-29-8885-8475  
FAX:+86-21-3356-2500

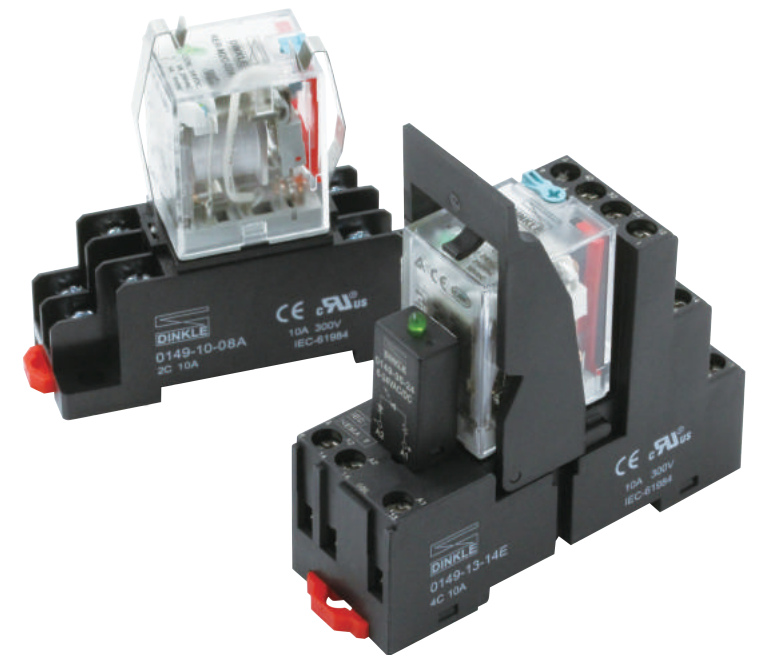



Dinkle, Delight through connections!!

Dinkle is one of the global major manufacturers of terminal blocks and committed to meet the highest application requirements of automation industry.

We continuously improve our productivity and competitive advantages, while keeping pace with the new production techniques and the global industrial trend. We work with trading offices in over 40 countries providing products and technical support services.

The business was established in Taiwan on July 22nd, 1983, it started from manufacturing barrier type terminal blocks. The first production facilities in China were set up in 1995, with 15 sales offices in Greater China region. Dinkle facilities include an R&D center for terminal blocks in Jiangsu, two OEM product development centers in KunShan and DongGuan city, an R&D center for electronics in Taipei, a CNAS certified laboratory in Jiangsu and two main production facilities in Jiangsu and Guangdong.

Terminal blocks are widely used in main industrial applications including Production Automation, Process Automation, Power Automation, Railway Transportation, New Energy and Equipment Manufacturing. All of our production facilities granted ISO 9001 quality control system certification and ISO 14001 environmental management system certification, and Dinkle's products have safety certifications include UL, CUL, CSA, VDE, GB. All products and materials used meet EU environmental policy of RoHS Directive and REACH regulation.

With more than 30 years of manufacturing experiences, Dinkle team is here to help to make your business successful. We provide reliable products and offer professional technical support and practical example to illustrate our solutions which are able to assist your business of improving production automation level and technical standards. No matter what your requirement is, you will find the ideal solution from Dinkle.



# RER Series Industrial Relay

10-11				
Type Description	RER-M2C-D24 Coil / 24VDC, Contact / 2C / 5A	RER-M2C-A120 Coil / 120VAC, Contact / 2C / 5A	RER-M2C-A230 Coil / 230VAC, Contact / 2C / 5A	
12-13				
Type Description	RER-M4C-D24 Coil / 24VDC, Contact / 4C / 3A	RER-M4C-A120 Coil / 120VAC, Contact / 4C / 3A	RER-M4C-A230 Coil / 230VAC, Contact / 4C / 3A	
14-15				
Type Description	RER-S2C-D24 Coil / 24VDC, Contact / 2C / 10A	RER-S2C-A120 Coil / 120VAC, Contact / 2C / 10A	RER-S2C-A230 Coil / 230VAC, Contact / 2C / 10A	
16-17				
Type Description	RER-S4C-D24 Coil / 24VDC, Contact / 4C / 5A	RER-S4C-A120 Coil / 120VAC, Contact / 4C / 5A	RER-S4C-A230 Coil / 230VAC, Contact / 4C / 5A	
18-19				
Type Description	0149-10-08A RER-M2 / RER-S2	0149-10-14A RER-M4 / RER-S4	0149-13-08E RER-M2 / RER-S2	0149-13-14E RER-M4 / RER-S4
20-21				
Type Description	RER-L2C-D24 Coil / 24VDC, Contact / 2C / 10A	RER-L2C-A120 Coil / 120VAC, Contact / 2C / 10A	RER-L2C-A230 Coil / 230VAC, Contact / 2C / 10A	
22-23				
Type Description	RER-L4C-D24 Coil / 24VDC, Contact / 4C / 10A	RER-L4C-A120 Coil / 120VAC, Contact / 4C / 10A	RER-L4C-A230 Coil / 230VAC, Contact / 4C / 10A	
24				
Type Description	0149-20-08A RER-L2	0149-20-14A RER-L4		

## RER Industrial Relay (Compact Type)

28-29				
Type Description	RER-J1C-D24 Coil / 24VDC, Contact / 1C / 10A	RER-J1C-A120 Coil / 120VAC, Contact / 1C / 10A	RER-J1C-A230 Coil / 230VAC, Contact / 1C / 10A	
30-31				
Type Description	RER-J2C-D24 Coil / 24VDC, Contact / 2C / 5A	RER-J2C-A120 Coil / 120VAC, Contact / 2C / 5A	RER-J2C-A230 Coil / 230VAC, Contact / 2C / 5A	
32-33				
Type Description	0149-30-05A RER-J1C	0149-30-08A RER-J2C	0149-33-05E RER-J1C	0149-33-08E RER-J2C

## Accessories





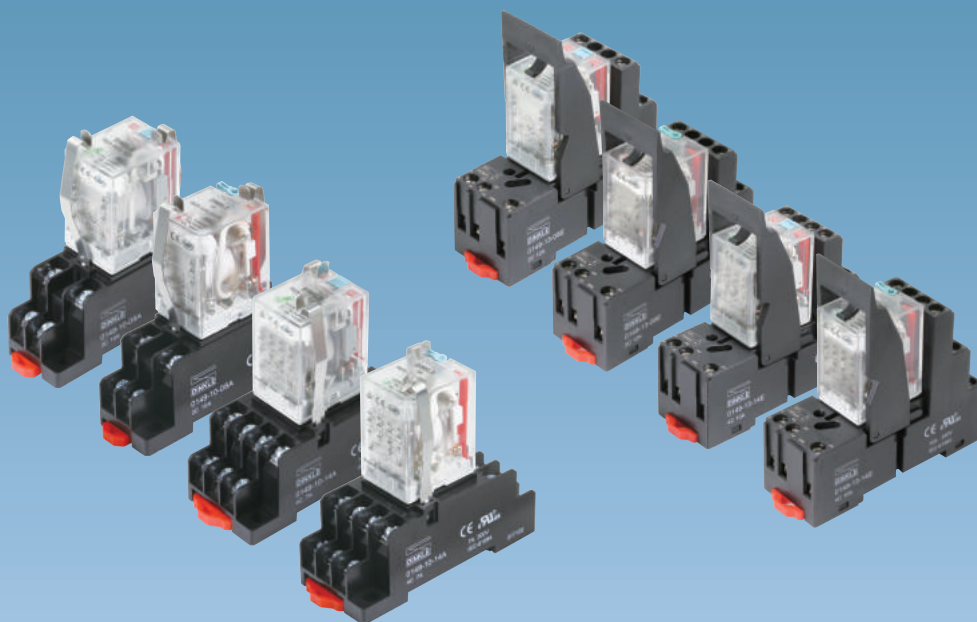

35			
Type Description	0149-11ES 0149-10-08A	0149-11 0149-10-14A	0149-21 0149-20-08A, 0149-20-14A
35			
Type Description	0149-14 0149-13-08E, 0149-13-14E	0149-32 0149-33-05E, 0149-33-08E,	
36			
Type Description	0149-36 0149-13-08E, 0149-13-14E, 0149-33-05E, 0149-33-08E	0149-35-24 0149-13-08E, 0149-13-14E, 0149-33-05E, 0149-33-08E	0149-35-240 0149-13-08E, 0149-13-14E, 0149-33-05E, 0149-33-08E

## The List of Kits

Relay with base	Voltage rating	Part number	Package Qty.	Relay with base	Voltage rating	Part number	Package Qty.
 <p>Contact / 2C / 5A</p>	24VDC	RER-M2C-D24 (A01)	10	 <p>Contact / 2C / 5A</p>	24VDC	RER-M2C-D24 (A03)	10
	120VAC	RER-M2C-A120 (A01)	10		120VAC	RER-M2C-A120 (A03)	10
	230VAC	RER-M2C-A230 (A01)	10		230VAC	RER-M2C-A230 (A03)	10
Relay with base	Voltage rating	Part number	Package Qty.	Relay with base	Voltage rating	Part number	Package Qty.
 <p>Contact / 2C / 10A</p>	24VDC	RER-S2C-D24 (A01)	10	 <p>Contact / 2C / 10A</p>	24VDC	RER-S2C-D24 (A03)	10
	120VAC	RER-S2C-A120 (A01)	10		120VAC	RER-S2C-A120 (A03)	10
	230VAC	RER-S2C-A230 (A01)	10		230VAC	RER-S2C-A230 (A03)	10
Relay with base	Voltage rating	Part number	Package Qty.	Relay with base	Voltage rating	Part number	Package Qty.
 <p>Contact / 4C / 3A</p>	24VDC	RER-M4C-D24 (A02)	10	 <p>Contact / 4C / 3A</p>	24VDC	RER-M4C-D24 (A04)	10
	120VAC	RER-M4C-A120 (A02)	10		120VAC	RER-M4C-A120 (A04)	10
	230VAC	RER-M4C-A230 (A02)	10		230VAC	RER-M4C-A230 (A04)	10
Relay with base	Voltage rating	Part number	Package Qty.	Relay with base	Voltage rating	Part number	Package Qty.
 <p>Contact / 4C / 5A</p>	24VDC	RER-S4C-D24 (A02)	10	 <p>Contact / 4C / 5A</p>	24VDC	RER-S4C-D24 (A04)	10
	120VAC	RER-S4C-A120 (A02)	10		120VAC	RER-S4C-A120 (A04)	10
	230VAC	RER-S4C-A230 (A02)	10		230VAC	RER-S4C-A230 (A04)	10



## The List of Kits

Relay with base	Voltage rating	Part number	Package Qty.	Relay with base	Voltage rating	Part number	Package Qty.
 Contact / 2C / 10A	24VDC	RER-L2C-D24 (A05)	10	 Contact / 4C / 10A	24VDC	RER-L4C-D24 (A06)	10
	120VAC	RER-L2C-A120 (A05)	10		120VAC	RER-L4C-A120 (A06)	10
	230VAC	RER-L2C-A230 (A05)	10		230VAC	RER-L4C-A230 (A06)	10
Relay with base	Voltage rating	Part number	Package Qty.	Relay with base	Voltage rating	Part number	Package Qty.
 Contact / 1C / 10A	24VDC	RER-J1C-D24 (A07)	10	 Contact / 1C / 10A	24VDC	RER-J1C-D24 (A09)	10
	120VAC	RER-J1C-A120 (A07)	10		120VAC	RER-J1C-A120 (A09)	10
	230VAC	RER-J1C-A230 (A07)	10		230VAC	RER-J1C-A230 (A09)	10
Relay with base	Voltage rating	Part number	Package Qty.	Relay with base	Voltage rating	Part number	Package Qty.
 Contact / 2C / 5A	24VDC	RER-J2C-D24 (A08)	10	 Contact / 2C / 5A	24VDC	RER-J2C-D24 (A10)	10
	120VAC	RER-J2C-A120 (A08)	10		120VAC	RER-J2C-A120 (A10)	10
	230VAC	RER-J2C-A230 (A08)	10		230VAC	RER-J2C-A230 (A10)	10

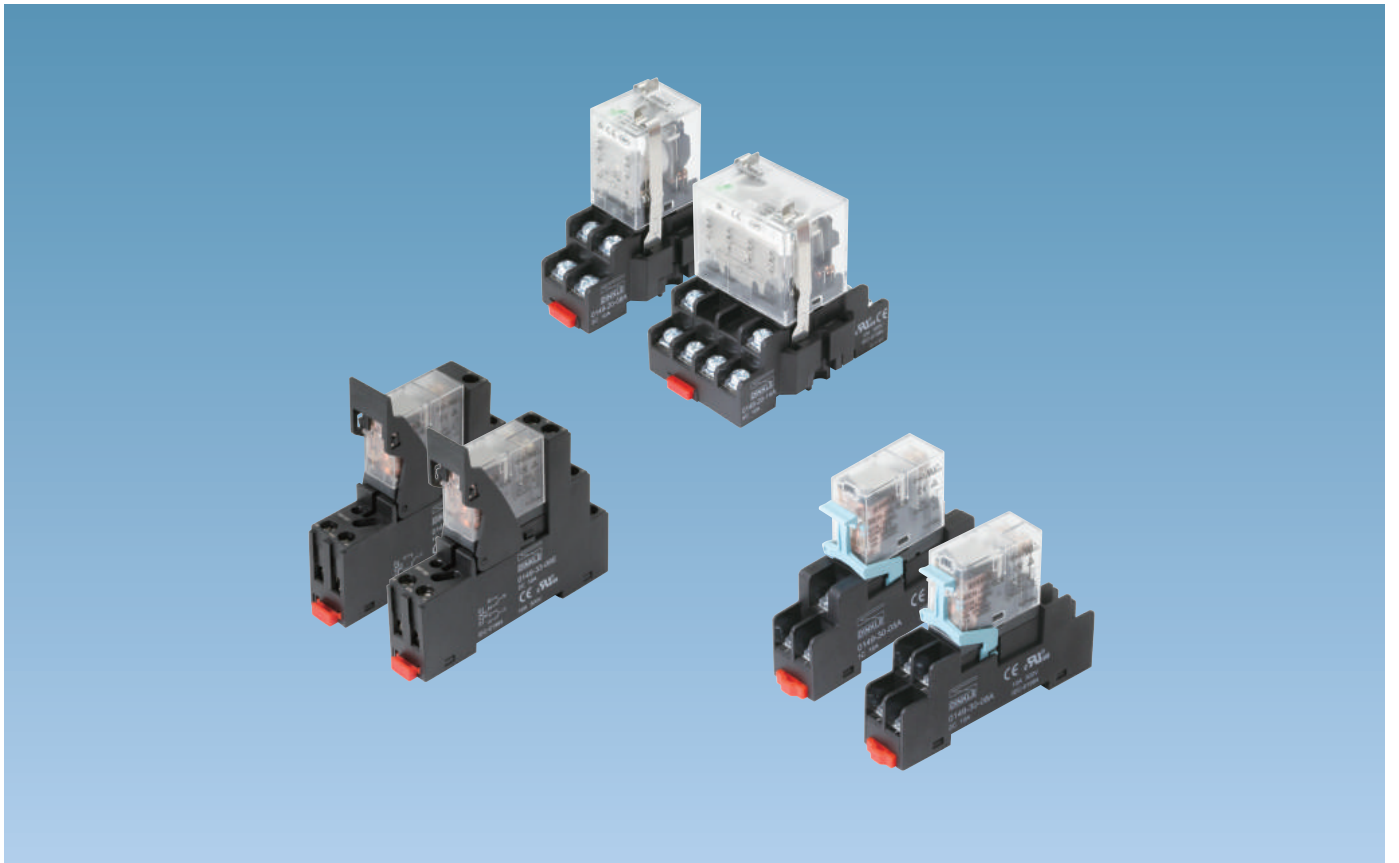



# Industrial Relay

In the field of electrical control, the pluggable industrial relay is generally used in electrical isolation, electrical transmission, and amplifying the coordination with signals, such as DCS, PLC, and the application between I/O systems and on-site sensors with actuators.





### Product Description

Dinkle's RER series of Industrial Relay fits the actual needs of the appropriate application in industrial control. It is stable and reliable with longer life time.



### Product Features

- Compact design, high rated loadings
- With optional test buttons of inching movement or self-locking, all products are equipped with mechanical switch position indicator.
- Reasonable structure, wide range applications.
- Various specifications with integrated status display.
- Contact made by industrial AgNi alloy.

### Product Certification



## Product Structure

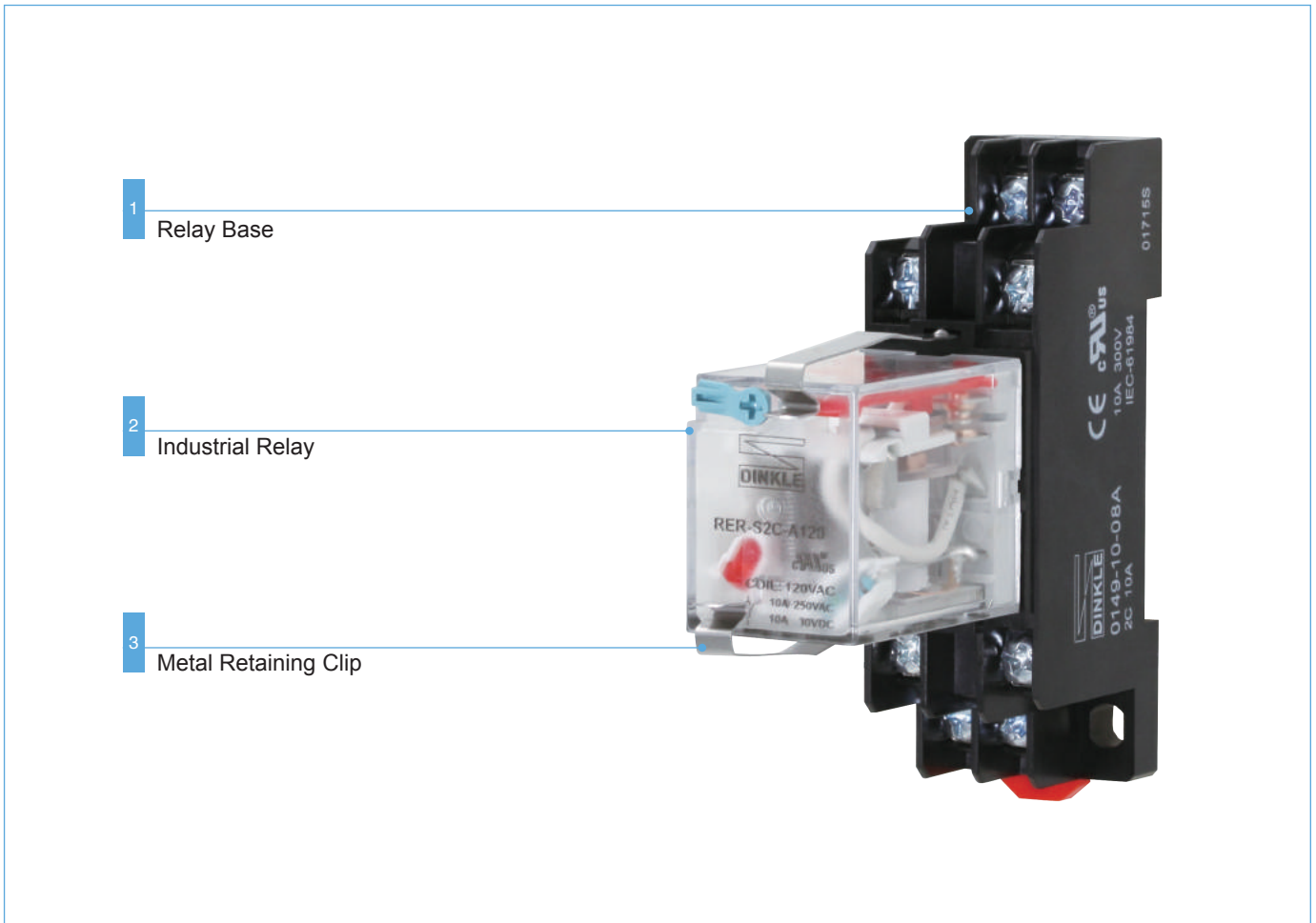

## Product Application

Dinkle's RER Industrial Relays are in electromagnetic design, it is mainly used between control units and on-site devices, which achieve the effects of electrical isolation, voltage matching, noise suppression and signal amplification.

## Working Mode

When the control voltage goes through the coil, the output contacts of relay will be energized by the electromagnetic effect; when the control voltage is cut off, the output contacts will return to its initial position.

# RER-M2C-XXXX

①    ②    ③

- ① M = Spec.
- ② 2C = No. of contacts
- ③ XXXX = Voltage
  - D24 = DC24V
  - A120 = AC120V
  - A230 = AC230V



## Specification

### Coil Characteristics

Rated voltage	24VDC	120VAC	230VAC
Rated current	36.9mA	9.2mA	5.5mA
Coil resistance	640 Ω ± 10%	4430 Ω ± 15%	4430 Ω ± 15%
Operated voltage (at 23°C)	18V(≤Rated voltage 75%)	96V(≤Rated voltage 80%)	184V(≤Rated voltage 80%)
Release voltage (at 23°C)	2.4V(≥Rated voltage 10%)	36V(≥Rated voltage 30%)	69V(≥Rated voltage 30%)
Max. Allowable voltage (at 23°C)	26.4V(Rated voltage 110%)	132V(Rated voltage 110%)	253V(Rated voltage 110%)
Coil power consumption	0.9W	1.2VA	1.2VA
LED Status display	Green/DC	Red/AC	Red/AC

### Contact Characteristics

No. of contacts	2C
Resistive load (AC-1)	5A/250VAC, 30VDC
Motor load (AC-15)	1/3HP 120VAC, 1/2HP 240VAC
Operating power (resistive)	1250VA, 150W
Min. allowable load	10mA/17V
Contact material	AgNi
Contact resistance	≤50mΩ

### Dielectric Strength

Between adjacent contacts	1000VAC/1min
Between open contacts / between live parts and ground	1500VAC/1min
Between contact and coil	2000VAC/1min
Insulation resistance	≥500MΩ (500VDC)

### General Characteristics

Operate time (rated voltage)	≤20ms
Release time (rated voltage)	≤20ms
Operating frequency	18000 Ops/h
Ambient temperature	-55~+70°C (Non-freezing condition)
Ambient humidity	35%~85%RH
Atmospheric pressure	86~106KPa
Impact resistance	10G
Vibration resistance	10~55Hz
Electrical life (frequency: on for 1s, off for 1s)	≥10 <sup>5</sup> (1800 Ops/h)
Mechanical life (frequency: 300 cycles/1 min)	≥10 <sup>7</sup> (18000 Ops/h)
Weight per piece	About 35g

## Relay Base and Accessories

Part Number	Product Description	Package Quantity	Specification
RER-M2C-XXXX	2C, 5A, with indicator and control button	20	--
0149-10-08A	Screw connection relay base, DIN rail mounting	10	RER-M2C-XXXX
0149-11ES	Metal retaining clip	20	0149-10-08A
0149-13-08E	Clamping connection relay base, DIN rail mounting	10	RER-M2C-XXXX
0149-14	Pastic retaining clip	5	0149-13-08E
0149-36	6~250VDC Volt.suppression component	10	0149-13-08E
0149-35-24	6-24VAC / DC LED indicator	10	0149-13-08E
0149-35-240	110-240VAC / DC LED indicator	10	0149-13-08E

## Performace Curve

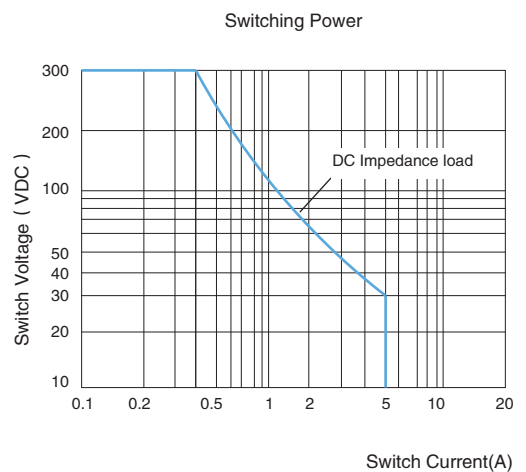
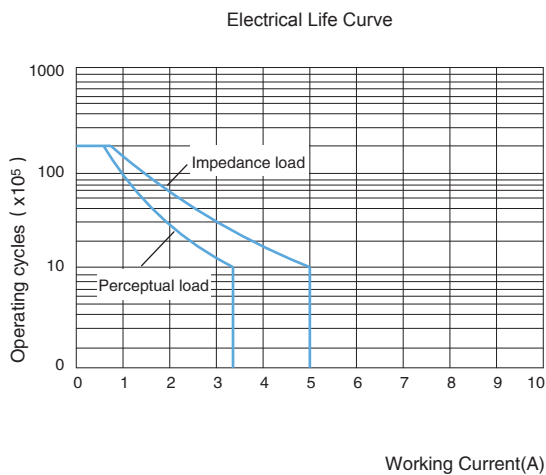

## Electrical Connections and Dimensions

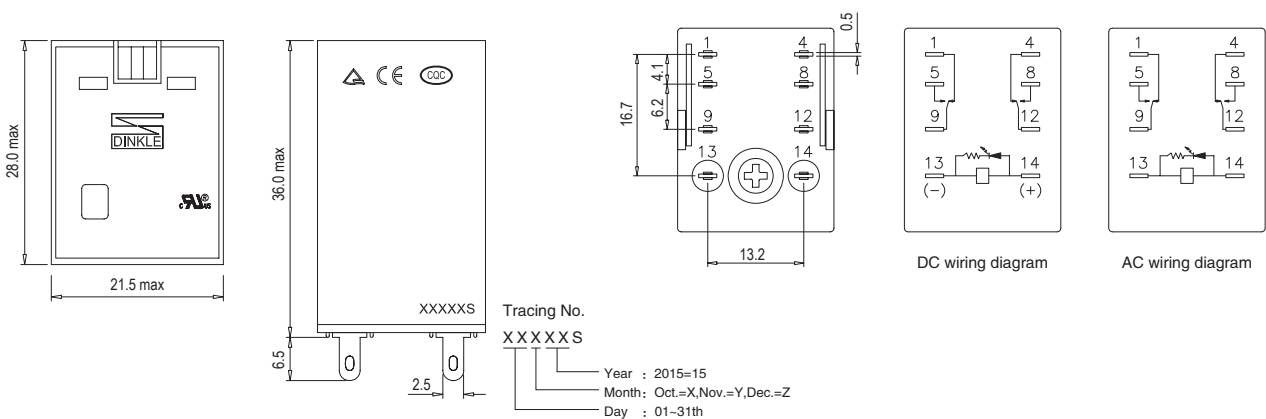

# RER-M4C-XXXX

①      ②      ③

- ① M = Spec.
- ② 4C = No. of contacts
- ③ XXXX = Voltage
  - D24 = DC24V
  - A120 = AC120V
  - A230 = AC230V



## Specification

### Coil Characteristics

Rated voltage	24VDC	120VAC	230VAC
Rated current	36.9mA	9.2mA	5.5mA
Coil resistance	640 Ω ± 10%	4430 Ω ± 15%	4430 Ω ± 15%
Operated voltage (at 23°C)	18V(≤ Rated voltage 75%)	96V(≤ Rated voltage 80%)	184V(≤ Rated voltage 80%)
Release voltage (at 23°C)	2.4V(≥ Rated voltage 10%)	36V(≥ Rated voltage 30%)	69V(≥ Rated voltage 30%)
Max. Allowable voltage (at 23°C)	26.4V(Rated voltage 110%)	132V(Rated voltage 110%)	253V(Rated voltage 110%)
Coil power consumption	0.9W	1.2VA	1.2VA
LED Status display	Green/DC	Red/AC	Red/AC

### Contact Characteristics

No. of contacts	4C
Resistive load (AC-1)	3A/250VAC, 30VDC
Motor load (AC-15)	1/3HP 240VAC, 1/6HP 240VAC
Operating power (resistive)	750VA, 90W
Min. allowable load	10mA/17V
Contact material	AgNi
Contact resistance	≤ 50mΩ

### Dielectric Strength

Between adjacent contacts	1000VAC/1min
Between open contacts / between live parts and ground	1500VAC/1min
Between contact and coil	2000VAC/1min
Insulation resistance	≥ 500MΩ (500VDC)

### General Characteristics

Operate time (rated voltage)	≤ 20ms
Release time (rated voltage)	≤ 20ms
Operating frequency	18000 Ops/h
Ambient temperature	-55~+70°C (Non-freezing condition)
Ambient humidity	35%~85%RH
Atmospheric pressure	86~106KPa
Impact resistance	10G
Vibration resistance	10~55Hz
Electrical life (frequency: on for 1s, off for 1s)	≥ 10 <sup>5</sup> (1800 Ops/h)
Mechanical life (frequency: 300 cycles/1 min)	≥ 10 <sup>7</sup> (18000 Ops/h)
Weight per piece	About 35g

# Relay Base and Accessories

Part Number	Product Description	Package Quantity	Specification
<b>RER-M4C-XXXX</b>	4C, 3A, with indicator and control button	20	--
<b>0149-10-14A</b>	Screw connection relay base, DIN rail mounting	10	RER-M4C-XXXX
<b>0149-11</b>	Metal retaining clip	20	0149-10-14A
<b>0149-13-14E</b>	Clamping connection relay base, DIN rail mounting	10	RER-M4C-XXXX
<b>0149-14</b>	Pastic retaining clip	5	0149-13-14E
<b>0149-36</b>	6~250VDC Volt.suppression component	10	0149-13-14E
<b>0149-35-24</b>	6-24VAC / DC LED indicator	10	0149-13-14E
<b>0149-35-240</b>	110-240VAC / DC LED indicator	10	0149-13-14E

## Performance Curve

Electrical Life Curve

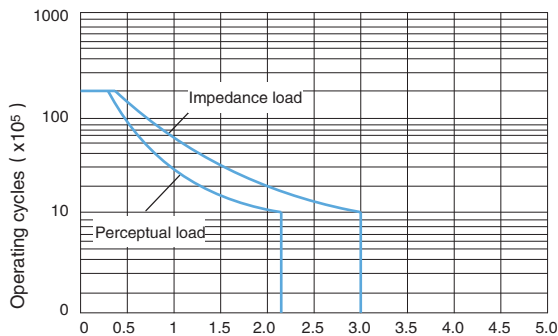

Working Current(A)

Switching Power

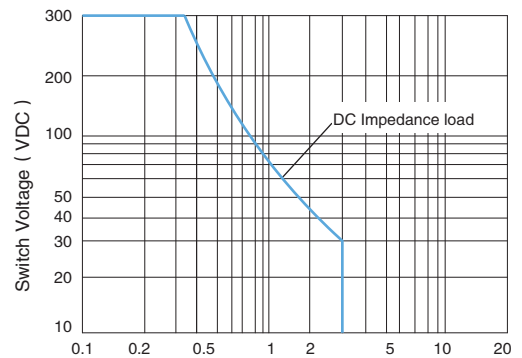

Switch Current(A)

## Electrical Connections and Dimensions

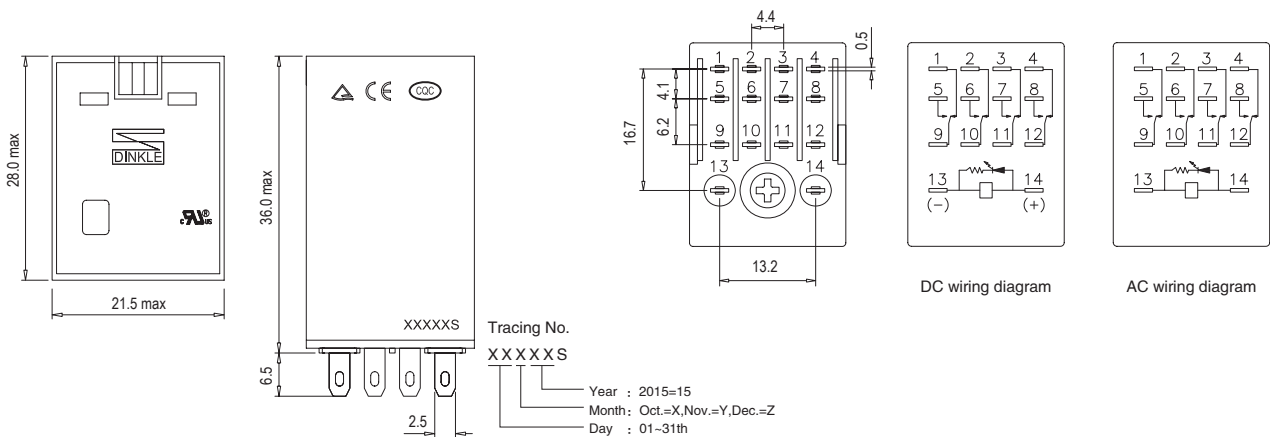

# RER-S2C-XXXX

① ② ③

- ① S = Spec.
- ② 2C = No. of contacts
- ③ XXXX = Voltage
  - D24 = DC24V
  - A120 = AC120V
  - A230 = AC230V



## Specification

### Coil Characteristics

Rated voltage	24VDC	120VAC	230VAC
Rated current	36.9mA	9.2mA	5.5mA
Coil resistance	640 Ω ± 10%	4430 Ω ± 15%	4430 Ω ± 15%
Operated voltage (at 23°C)	18V(≤Rated voltage 75%)	96V(≤Rated voltage 80%)	184V(≤Rated voltage 80%)
Release voltage (at 23°C)	2.4V(≥Rated voltage 10%)	36V(≥Rated voltage 30%)	69V(≥Rated voltage 30%)
Max. Allowable voltage (at 23°C)	26.4V(Rated voltage 110%)	132V(Rated voltage 110%)	253V(Rated voltage 110%)
Coil power consumption	0.9W	1.2VA	1.2VA
LED Status display	Green/DC	Red/AC	Red/AC

### Contact Characteristics

No. of contacts	2C
Resistive load (AC-1)	10A/250VAC, 30VDC
Motor load (AC-15)	1/3HP 120VAC, 1/2HP 240VAC
Operating power (resistive)	2500VA, 300W
Min. allowable load	10mA/17V
Contact material	AgNi
Contact resistance	≤50mΩ

### Dielectric Strength

Between adjacent contacts	1000VAC/1min
Between open contacts / between live parts and ground	1500VAC/1min
Between contact and coil	2000VAC/1min
Insulation resistance	≥500MΩ (500VDC)

### General Characteristics

Operate time (rated voltage)	≤20ms
Release time (rated voltage)	≤20ms
Operating frequency	18000 Ops/h
Ambient temperature	-55~+70°C (Non-freezing condition )
Ambient humidity	35%~85%RH
Atmospheric pressure	86~106KPa
Impact resistance	10G
Vibration resistance	10~55Hz
Electrical life (frequency: on for 1s, off for 1s)	≥10 <sup>5</sup> (1800 Ops/h)
Mechanical life (frequency: 300 cycles/1 min)	≥10 <sup>7</sup> (18000 Ops/h)
Weight per piece	About 35g

## Relay Base and Accessories

Part Number	Product Description	Package Quantity	Specification
RER-S2C-XXXX	2C, 10A, with indicator and control button	20	--
0149-10-08A	Screw connection relay base, DIN rail mounting	10	RER-S2C-XXXX
0149-11ES	Metal retaining clip	20	0149-10-08A
0149-13-08E	Clamping connection relay base, DIN rail mounting	10	RER-S2C-XXXX
0149-14	Pastic retaining clip	5	0149-13-08E
0149-36	6~250VDC Volt.suppression component	10	0149-13-08E
0149-35-24	6-24VAC / DC LED indicator	10	0149-13-08E
0149-35-240	110-240VAC / DC LED indicator	10	0149-13-08E

## Performace Curve

Electrical Life Curve

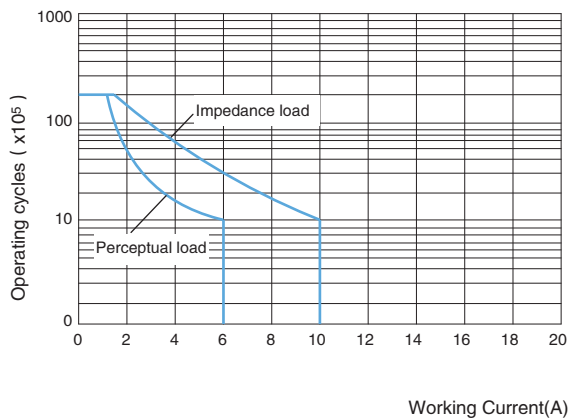

Switching Power

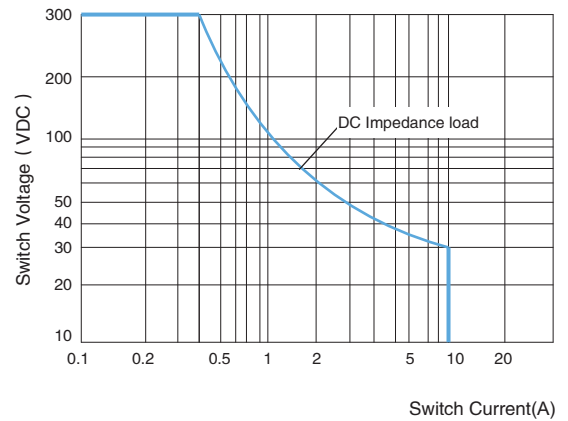

## Electrical Connections and Dimensions

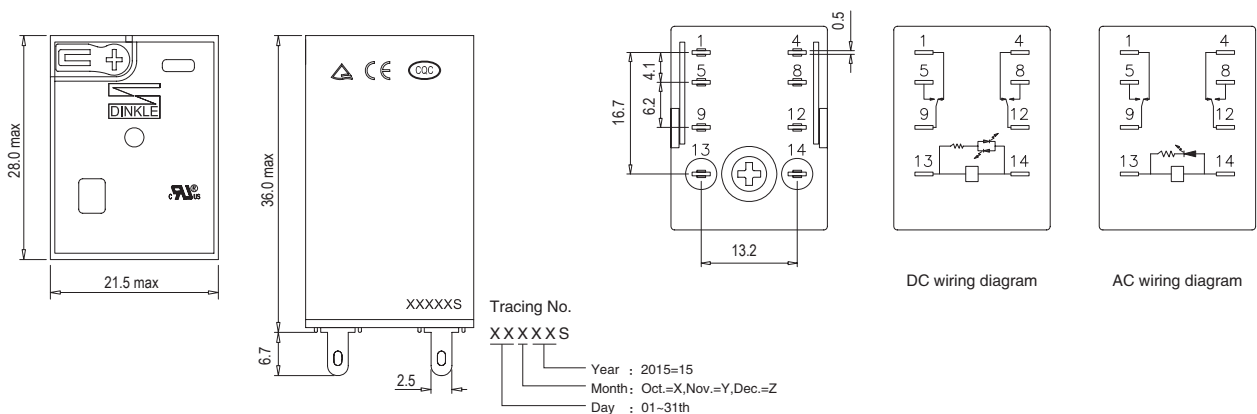



# RER-S4C-XXXX

①    ②                    ③

- ① S = Spec.
- ② 4C = No. of contacts
- ③ XXXX = Voltage
  - D24 = DC24V
  - A120 = AC120V
  - A230 = AC230V



## Specification

### Coil Characteristics

Rated voltage	24VDC	120VAC	230VAC
Rated current	36.9mA	9.2mA	5.5mA
Coil resistance	640 Ω ± 10%	4430 Ω ± 15%	4430 Ω ± 15%
Operated voltage (at 23°C)	18V(≤Rated voltage 75%)	96V(≤Rated voltage 80%)	184V(≤Rated voltage 80%)
Release voltage (at 23°C)	2.4V(≥Rated voltage 10%)	36V(≥Rated voltage 30%)	69V(≥Rated voltage 30%)
Max. Allowable voltage (at 23°C)	26.4V(Rated voltage 110%)	132V(Rated voltage 110%)	253V(Rated voltage 110%)
Coil power consumption	0.9W	1.2VA	1.2VA
LED Status display	Green/DC	Red/AC	Red/AC

### Contact Characteristics

No. of contacts	4C
Resistive load (AC-1)	5A/250VAC, 30VDC
Motor load (AC-15)	1/3HP, 240VAC, 1/6HP, 240VAC
Operating power (resistive)	1250VA, 150W
Min. allowable load	10mA/17V
Contact material	AgNi
Contact resistance	≤50mΩ

### Dielectric Strength

Between adjacent contacts	1000VAC/1min
Between open contacts / between live parts and ground	1500VAC/1min
Between contact and coil	2000VAC/1min
Insulation resistance	≥500MΩ (500VDC)

### General Characteristics

Operate time (rated voltage)	≤20ms
Release time (rated voltage)	≤20ms
Operating frequency	18000 Ops/h
Ambient temperature	-55~+70°C (Non-freezing condition )
Ambient humidity	35%~85%RH
Atmospheric pressure	86~106KPa
Impact resistance	10G
Vibration resistance	10~55Hz
Electrical life (frequency: on for 1s, off for 1s)	≥10 <sup>5</sup> 次 (1800 Ops/h)
Mechanical life (frequency: 300 cycles/1 min)	≥10 <sup>7</sup> 次 (18000 Ops/h)
Weight per piece	About 35g

# Relay Base and Accessories

Part Number	Product Description	Package Quantity	Specification
RER-S4C-XXXX	4C, 5A, with indicator and control button	20	--
0149-10-14A	Screw connection relay base, DIN rail mounting	10	RER-S4C-XXXX
0149-11	Metal retaining clip	20	0149-10-14A
0149-13-14E	Clamping connection relay base, DIN rail mounting	10	RER-S4C-XXXX
0149-14	Pastic retaining clip	5	0149-13-14E
0149-36	6~250VDC Volt.suppression component	10	0149-13-14E
0149-35-24	6-24VAC / DC LED indicator	10	0149-13-14E
0149-35-240	110-240VAC / DC LED indicator	10	0149-13-14E

# Performace Curve

Electrical Life Curve

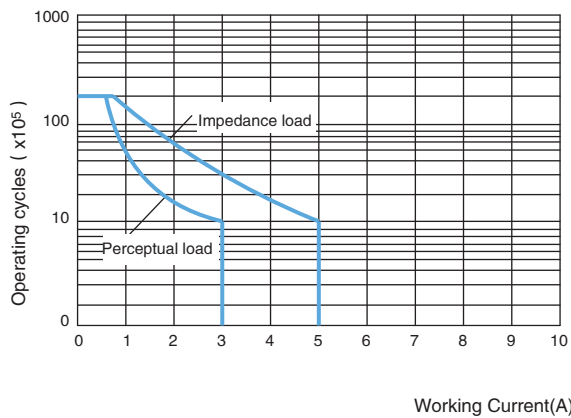

Switching Power

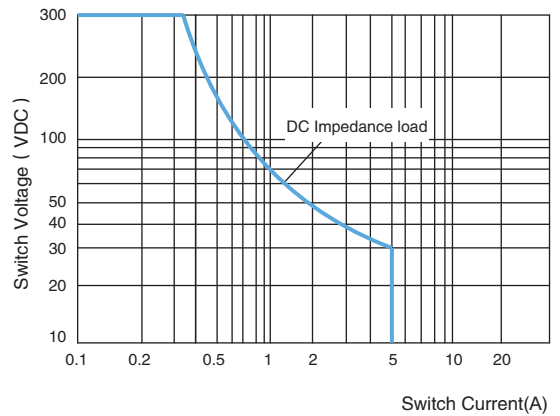

# Electrical Connections and Dimensions

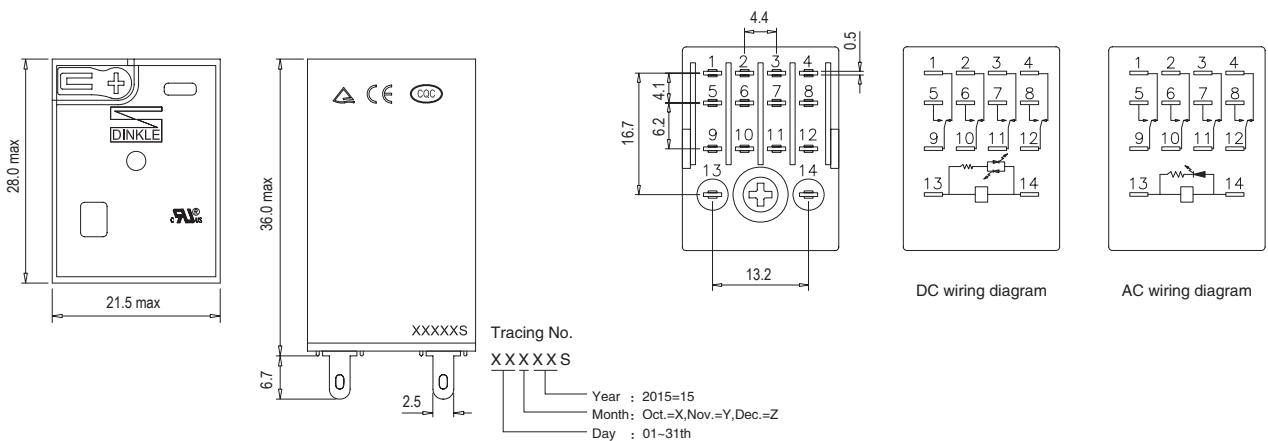

## Specifications of Relay Base



Part Number	0149-10-08A	0149-10-14A
Rated load current	10A	7A
Rated load voltage	300V	300V
Insulation resistance	2000V/s	2000V/s
Screw torque	1.0Nm	1.0Nm
External connection wire	20-14 / 0.5-2.5 (AWG/mm <sup>2</sup> )	20-14 / 0.5-2.5 (AWG/mm <sup>2</sup> )
Ambient temperature	-40~+65°C	-40~+65°C
Weight	About 34g	About 52g
Min. packing quantity	10pcs	10pcs
Mating part	RER-M2C / RER-S2C	RER-M4C / RER-S4C
<b>Accessories</b>		
Pastic retaining clip		
Metal retaining clip	0149-11ES (@2pcs)	0149-11 (@2pcs)
Electronic components		
DIN rail	TS-35	TS-35

## Dimensions

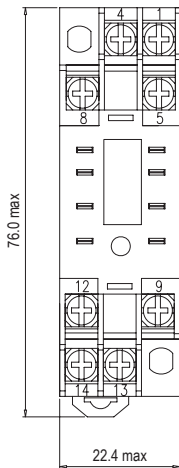

0149-10-08A

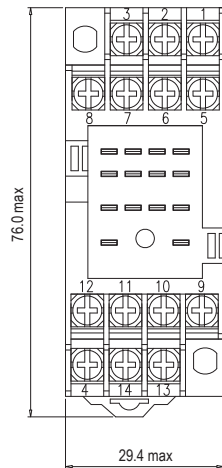

0149-10-14A

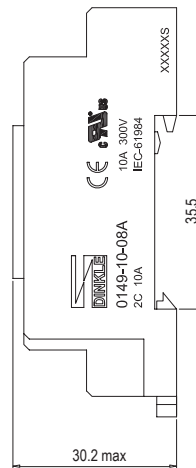

## Terminal Configuration and Internal Wiring Diagram

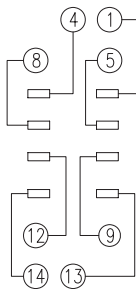

0149-10-08A

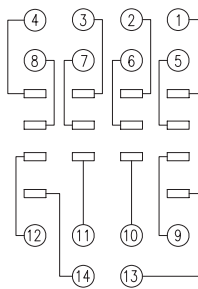

0149-10-14A

## Specifications of Relay Base



Part Number	0149-13-08E	0149-13-14E
Rated load current	12A	10A
Rated load voltage	300V	300V
Insulation resistance	2500V/s	2500V/s
Screw torque	1.0Nm	1.0Nm
External connection wire	20-14 / 0.5-2.5 (AWG/mm <sup>2</sup> )	20-14 / 0.5-2.5 (AWG/mm <sup>2</sup> )
Ambient temperature	-40~+85°C	-40~+85°C
Weight	About 50g	About 62g
Min. packing quantity	10pcs	10pcs
Mating part	RER-M2C / RER-S2C	RER-M4C / RER-S4C
<b>Accessories</b>		
Pastic retaining clip	0149-14 (@1pcs)	0149-14 (@1pcs)
Metal retaining clip		
Electronic components	0149-36 / 0149-35	0149-36 / 0149-35
DIN rail	TS-35	TS-35

## Dimensions

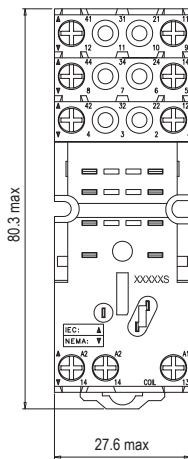

0149-13-08E

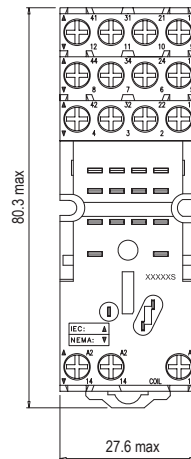

0149-13-14E

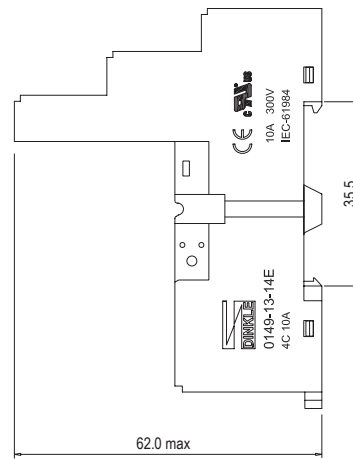

## Terminal configuration and internal wiring diagram

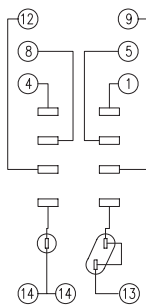

0149-13-08E

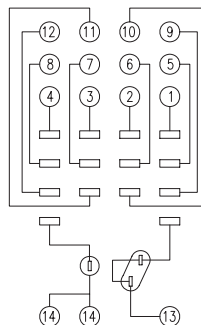

0149-13-14E

# RER-L2C-XXXX

①    ②    ③

- ① L = Spec.
- ② 2C = No. of contacts
- ③ XXXX = Voltage
  - D24 = DC24V
  - A120 = AC120V
  - A230 = AC230V



## Specification

Coil Characteristics			
Rated voltage	24VDC	120VAC	230VAC
Rated current	36.9mA	9.2mA	5.5mA
Coil resistance	640 Ω ± 10%	4430 Ω ± 15%	4430 Ω ± 15%
Operated voltage (at 23°C)	18V(≤Rated voltage 75%)	96V(≤Rated voltage 80%)	184V(≤Rated voltage 80%)
Release voltage (at 23°C)	2.4V(≥Rated voltage 10%)	36V(≥Rated voltage 30%)	69V(≥Rated voltage 30%)
Max. Allowable voltage (at 23°C)	26.4V(Rated voltage 110%)	132V(Rated voltage 110%)	253V(Rated voltage 110%)
Coil power consumption	0.9W	1.2VA	1.2VA
LED Status display	Green/DC	Red/AC	Red/AC
Contact Characteristics			
No. of contacts	2C		
Resistive load (AC-1)	10A/250VAC, 30VDC		
Motor load (AC-15)	1/3HP, 120VAC, 1/2HP, 240VAC		
Operating power (resistive)	2500VA, 300W		
Min. allowable load	10mA/17V		
Contact material	AgSnO <sub>2</sub>		
Contact resistance	≤50mΩ		
Dielectric Strength			
Between adjacent contacts	1000VAC/1min		
Between open contacts / between live parts and ground	2000VAC/1min		
Between contact and coil	2000VAC/1min		
Insulation resistance	≥500MΩ (500VDC)		
General Characteristics			
Operate time (rated voltage)	≤20ms		
Release time (rated voltage)	≤20ms		
Operating frequency	18000 Ops/h		
Ambient temperature	-25~+55°C (Non-freezing condition)		
Ambient humidity	35%~85%RH		
Atmospheric pressure	86~106KPa		
Impact resistance	10G		
Vibration resistance	10~55Hz		
Electrical life (frequency: on for 1s, off for 1s)	≥10 <sup>5</sup> (1800 Ops/h)		
Mechanical life (frequency: 300 cycles/1 min)	≥10 <sup>7</sup> (18000 Ops/h)		
Weight per piece	About 35g		

# Relay Base and Accessories

Part Number	Product Description	Package Quantity	Specification
RER-L2C-XXXX	2C, 10A, with indicator and control button	20	--
0149-20-08A	Screw connection relay base, DIN rail mounting	10	RER-L2C-XXXX
0149-21	Metal retaining clip	20	0149-20-08A

## Performace Curve

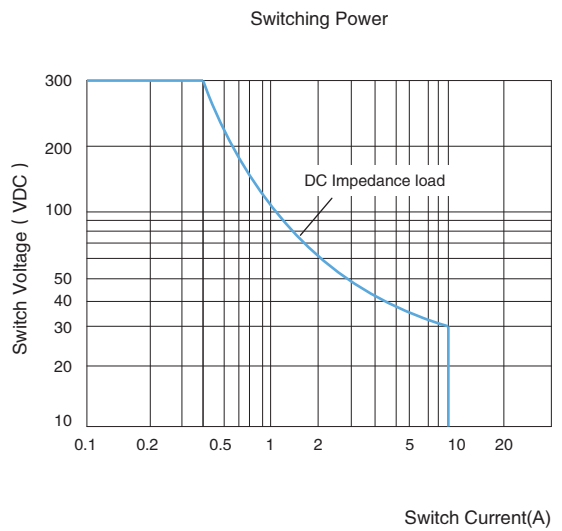
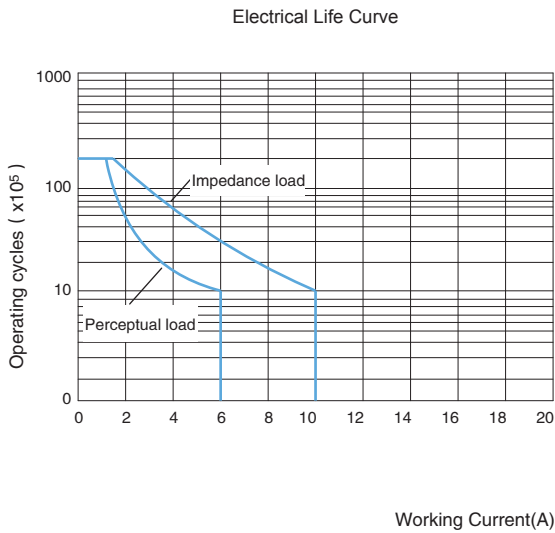

## Electrical Connections and Dimensions

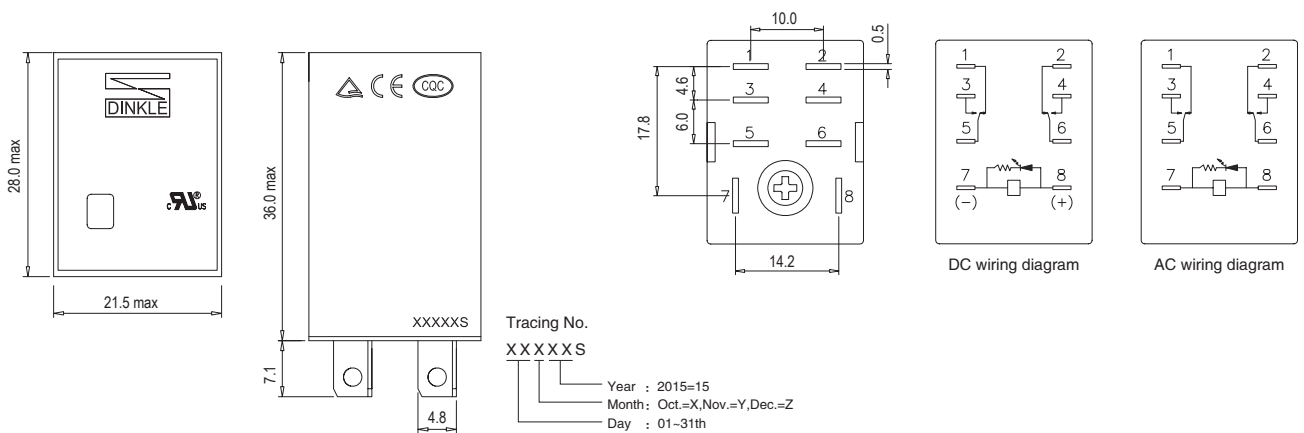

# RER-L4C-XXXX

①    ②    ③

- ① L = Spec.
- ② 4C = No. of contacts
- ③ XXXX = Voltage
  - D24 = DC24V
  - A120 = AC120V
  - A230 = AC230V



## Specification

Coil Characteristics			
Rated voltage	24VDC	120VAC	230VAC
Rated current	69mA	21.8mA	10.8mA
Coil resistance	360Ω ± 10%	4430Ω ± 15%	4430Ω ± 15%
Operated voltage (at 23°C)	18V(≤Rated Voltage 75%)	96V(≤Rated voltage 80%)	184V(≤Rated voltage 80%)
Release voltage (at 23°C)	2.4V(≥Rated Voltage 10%)	36V(≥Rated voltage 30%)	69V(≥Rated voltage 30%)
Max. Allowable voltage (at 23°C)	26.4V(Rated Voltage 110%)	132V(Rated voltage 110%)	253V(Rated voltage 110%)
Coil power consumption	1.5W	2.5VA	2.5VA
LED Status display	Green/VDC	Red/VAC	Red/VAC
Contact Characteristics			
No. of contacts	4C		
Resistive load (AC-1)	10A/250VAC, 30VDC		
Motor load (AC-15)	1/3HP, 120VAC, 1/2HP, 240VAC		
Operating power (resistive)	2500VA, 300W		
Min. allowable load	10mA/17V		
Contact material	AgSnO <sub>2</sub>		
Contact resistance	≤50mΩ		
Dielectric Strength			
Between adjacent contacts	1000VAC/1min		
Between open contacts / between live parts and ground	2000VAC/1min		
Between contact and coil	2000VAC/1min		
Insulation resistance	≥500MΩ (500VDC)		
General Characteristics			
Operate time (rated voltage)	≤20ms		
Release time (rated voltage)	≤20ms		
Operating frequency	18000 Ops/h		
Ambient temperature	-25~+55°C (Non-freezing condition )		
Ambient humidity	35%~85%RH		
Atmospheric pressure	86~106KPa		
Impact resistance	10G		
Vibration resistance	10~55Hz		
Electrical life (frequency: on for 1s, off for 1s)	≥10 <sup>5</sup> (1800 Ops/h)		
Mechanical life (frequency: 300 cycles/1 min)	≥10 <sup>7</sup> (18000 Ops/h)		
Weight per piece	About 65g		

# Relay Base and Accessories

Part Number	Product Description	Package Quantity	Specification
RER-L4C-XXXX	4C, 10A, with indicator and control button	20	--
0149-20-14A	Screw connection relay base, DIN rail mounting	10	RER-L4C-XXXX
0149-21	Metal retaining clip	20	0149-20-14A

## Performance Curve

Electrical Life Curve

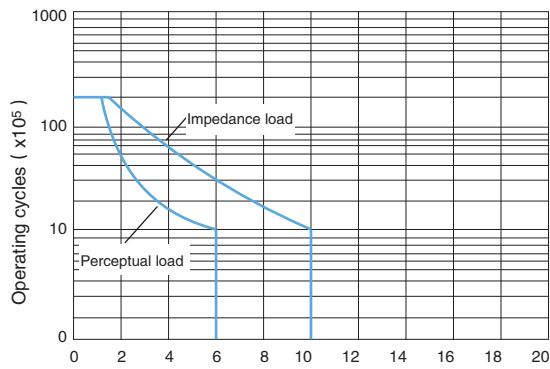

Working Current(A)

Switching Power

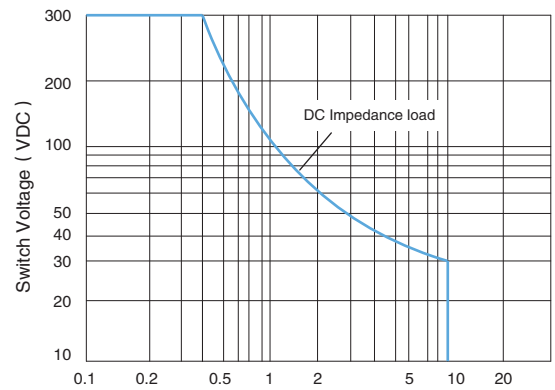

Switch Current(A)

## Electrical Connections and Dimensions

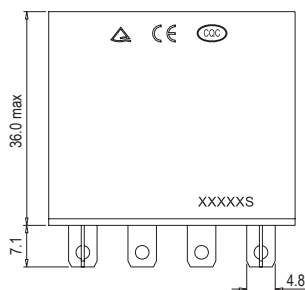
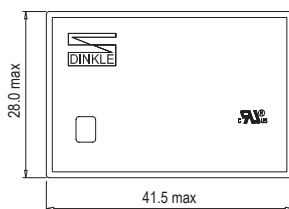

Tracing No.  
 XXXXS  
 Year : 2015=15  
 Month : Oct.=X,Nov.=Y,Dec.=Z  
 Day : 01-31th

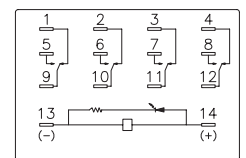
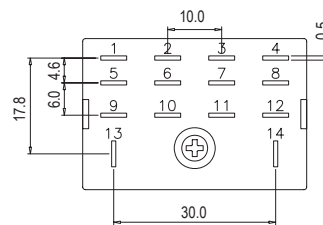

DC wiring diagram

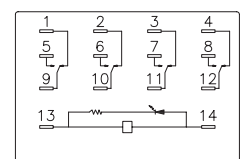

AC wiring diagram



## Specifications of Relay Base



Part Number	0149-20-08A	0149-20-14A
Rated load current	10A	10A
Rated load voltage	300V	300V
Insulation resistance	2000V/s	2000V/s
Screw torque	1.0Nm	1.0Nm
External connection wire	20-14 / 0.5-2.5 (AWG/mm <sup>2</sup> )	20-14 / 0.5-2.5 (AWG/mm <sup>2</sup> )
Ambient temperature	-40~+85°C	-40~+85°C
Weight	About 43g	About 76g
Min. packing quantity	10pcs	10pcs
Mating part	RER-L2C	RER-L4C
<b>Accessories</b>		
Pastic retaining clip		
Metal retaining clip	0149-21 (@2pcs)	0149-21 (@2pcs)
Electronic components		
DIN rail	TS-35	TS-35

## Dimensions

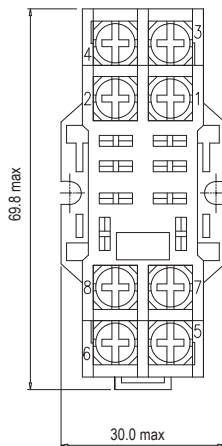

0149-20-08A

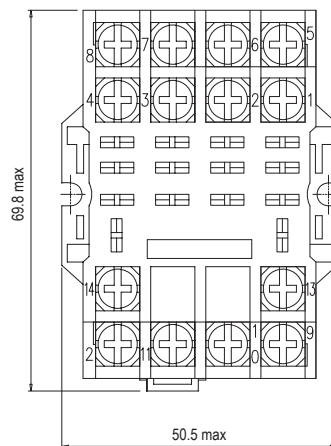

0149-20-14A

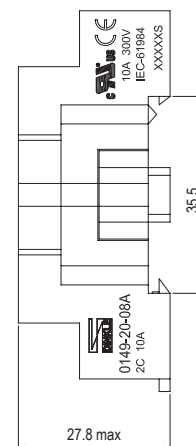

## Terminal Configuration Internal Wiring Diagram

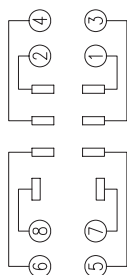

0149-20-08A

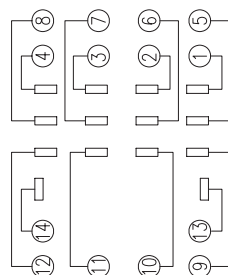

0149-20-14A

# Industrial Relay Compact Type

Bottom width is only 15.5mm, applicable to all kinds of electrical control field. It saves cabinet space in projects of mechanical equipment and systems integration.



## RER Industrial Relay (Compact Type)

### Product Description

Dinkle's RER series of Industrial Relay better fits the actual needs of the appropriate application in industrial control. It is stable and reliable with longer life time.

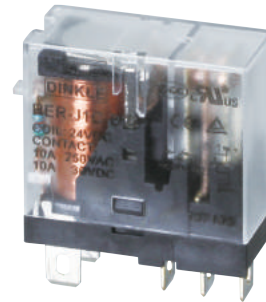

### Product Features

- Compact design, high rated loadings
- Reasonable structure, wide range application
- Various specifications with integrated status display
- Contact material by industrial AgSnO<sub>2</sub> alloy

### Product Certification



## RER Industrial Relay (Compact Type)

### Product Structure

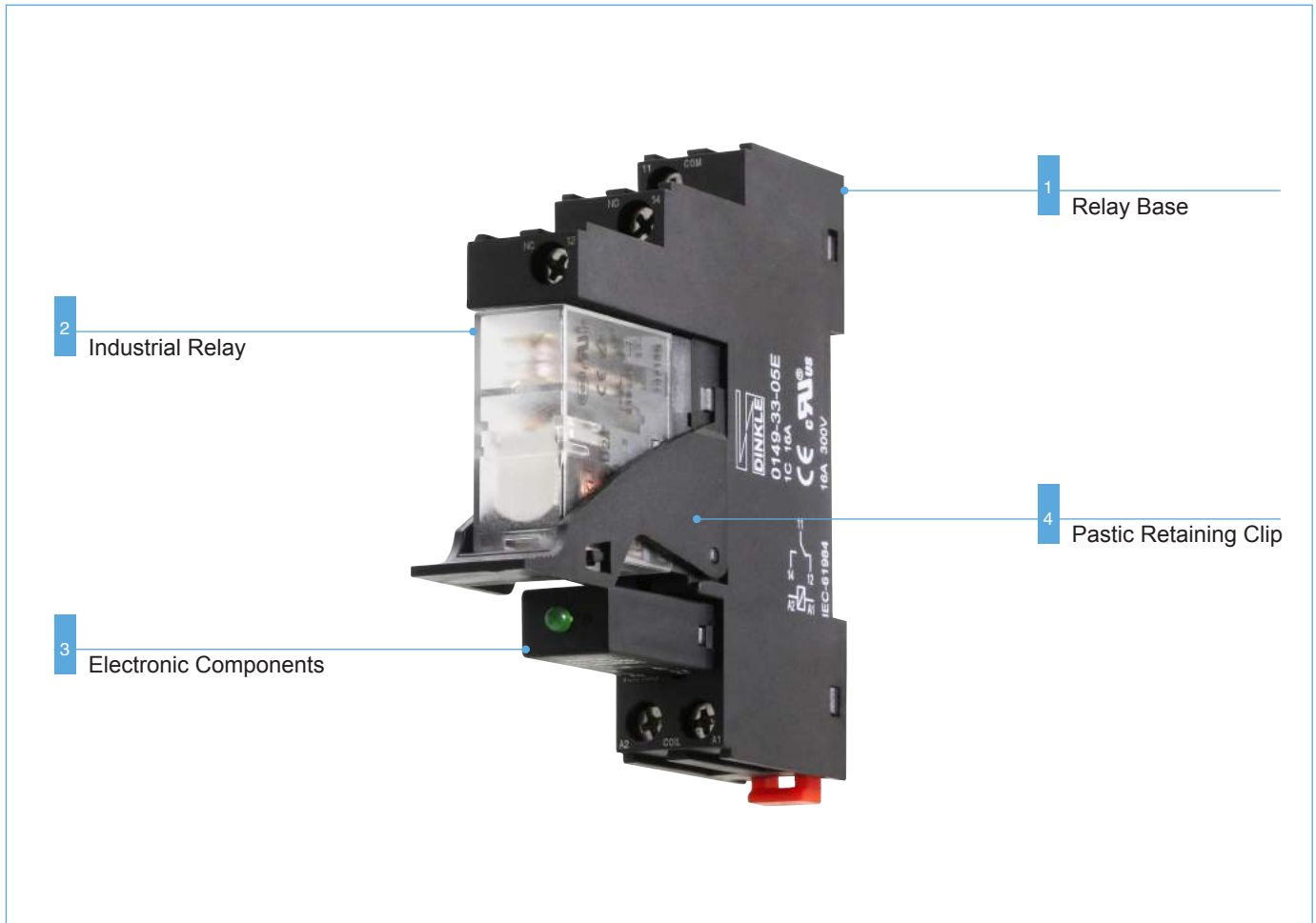

### Product Application

Dinkle's RER Industrial relays are in electromagnetic design, they are mainly used between control unit and the field devices to achieve the effects of electrical isolation, voltage matching, noise suppression and signal amplification.

### Working Mode

When the control voltage goes through the coil, the output contacts of relay will be energized by the electromagnetic effect. When the control voltage is cut off, the output contact will return to its initial position.

**RER-J1C-XXXX**

① ② ③

- ① J = Spec.  
 ② 1C = No. of contacts  
 ③ XXXX = Voltage  
     D24 = DC24V  
     A120 = AC120V  
     A230 = AC230V

**Specification**

Coil Characteristics			
Rated voltage	24VDC	120VAC	230VAC
Rated current	21.8mA	7.6mA	3.9mA
Coil resistance	1100 $\Omega$ $\pm$ 10%	4430 $\Omega$ $\pm$ 15%	4430 $\Omega$ $\pm$ 15%
Operated voltage (at 23°C)	18V( $\leq$ Rated voltage 75%)	96V( $\leq$ Rated voltage 80%)	184V( $\leq$ Rated voltage 80%)
Release voltage (at 23°C)	2.4V( $\geq$ Rated voltage 10%)	36V( $\geq$ Rated voltage 30%)	69V( $\geq$ Rated voltage 30%)
Max. Allowable voltage (at 23°C)	26.4V(Rated voltage 110%)	132V(Rated voltage 110%)	253V(Rated voltage 110%)
Coil power consumption	0.53W	1.0VA	1.0VA
LED Status display	Green/DC	Red/AC	Red/AC
Contact Characteristics			
No. of contacts	1C		
Resistive load (AC-1)	10A/250VAC, 30VDC		
Motor load (AC-15)	1/3HP, 240VAC, 1/2HP, 240VAC		
Operating power (resistive)	2500VA, 300W		
Min. allowable load	10mA/17V		
Contact material	AgSnO <sub>2</sub>		
Contact resistance	$\leq$ 50m $\Omega$		
Dielectric Strength			
Between adjacent contacts	1000VAC/1min		
Between open contacts / between live parts and ground	--		
Between contact and coil	5000VAC/1min		
Insulation resistance	$\geq$ 1000M $\Omega$ (500VDC)		
General Characteristics			
Operate time (rated voltage)	$\leq$ 20ms		
Release time (rated voltage)	$\leq$ 20ms		
Operating frequency	18000 Ops/h		
Ambient temperature	-40~+55°C (Non-freezing condition)		
Ambient humidity	35%~85%RH		
Atmospheric pressure	86~106KPa		
Impact resistance	10G		
Vibration resistance	10~55Hz		
Electrical life (frequency: on for 1s, off for 1s)	$\geq$ 10 <sup>5</sup> (1800 Ops/h)		
Mechanical life (frequency: 300 cycles/1 min)	$\geq$ 10 <sup>7</sup> (18000 Ops/h)		
Weight per piece	About 19g		

## Relay Base and Accessories

Part Number	Product Description	Package Quantity	Specification
<b>RER-J1C-XXXX</b>	1C, 10A, with indicator and control button	20	--
<b>0149-30-05A</b>	Screw connection relay base, DIN rail mounting	10	RER-J1C-XXXX
<b>0149-33-05E</b>	Clamping connection relay base, DIN rail mounting	10	RER-J1C-XXXX
<b>0149-32</b>	Pastic retaining clip	10	0149-33-05E
<b>0149-36</b>	6~250VDC Volt.suppression component	10	0149-33-05E
<b>0149-35-24</b>	6-24VAC / DC LED indicator	10	0149-33-05E
<b>0149-35-240</b>	110-240VAC / DC LED indicator	10	0149-33-05E

## Performace Curve

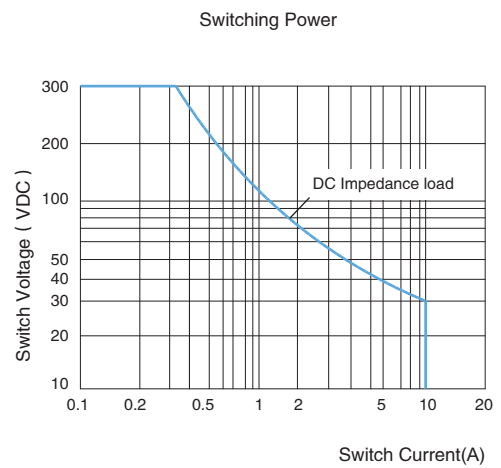
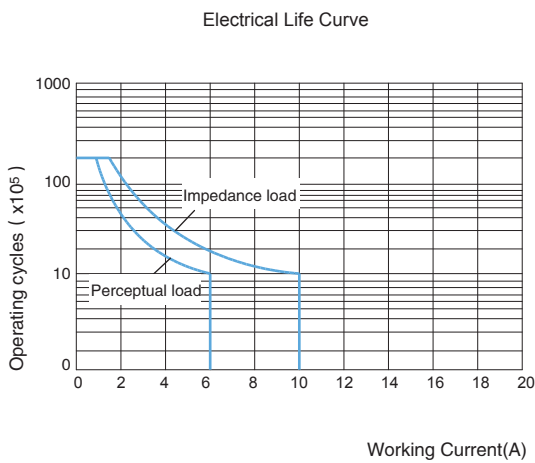

## Electrical Connections and Dimensions

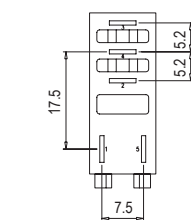
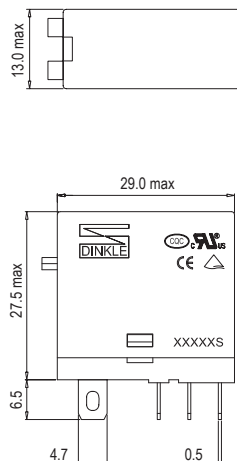

Tracing No.

XXXXXS

Year : 2015=15

Month : Oct.=X,Nov.=Y,Dec.=Z

Day : 01-31th

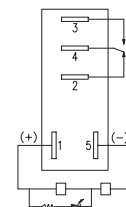

DC wiring diagram

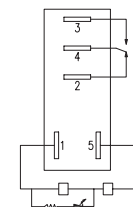

AC wiring diagram

# RER-J2C-XXXX

①      ②      ③

- ① J = Spec.
- ② 2C = No. of contacts
- ③ XXXX = Voltage
  - D24 = DC24V
  - A120 = AC120V
  - A230 = AC230V

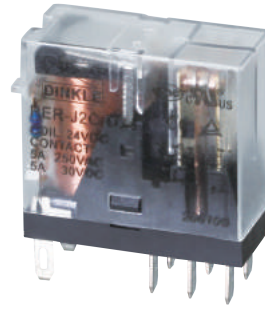

## Specification

Coil Characteristics			
Rated voltage	24VDC	120VAC	230VAC
Rated current	21.8mA	7.6mA	3.9mA
Coil resistance	1100Ω ± 10%	4430Ω ± 15%	4430Ω ± 15%
Operated voltage (at 23°C)	18V(≤Rated voltage 75%)	96V(≤Rated voltage 80%)	184V(≤Rated voltage 80%)
Release voltage (at 23°C)	2.4V(≥Rated voltage 10%)	36V(≥Rated voltage 30%)	69V(≥Rated voltage 30%)
Max. Allowable voltage (at 23°C)	26.4V(Rated voltage 110%)	132V(Rated voltage 110%)	253V(Rated voltage 110%)
Coil power consumption	0.53W	1.0VA	1.0VA
LED Status display	Green/DC	Red/AC	Red/AC
Contact Characteristics			
No. of contacts	2C		
Resistive load (AC-1)	5A/250VAC, 30VDC		
Motor load (AC-15)	1/6HP, 240VAC		
Operating power (resistive)	1250VA, 150W		
Min. allowable load	10mA/17V		
Contact material	AgSnO <sub>2</sub>		
Contact resistance	≤50mΩ		
Dielectric Strength			
Between adjacent contacts	1000VAC/1min		
Between open contacts / between live parts and ground	1000VAC/1min		
Between contact and coil	5000VAC/1min		
Insulation resistance	≥1000MΩ (500VDC)		
General Characteristics			
Operate time (rated voltage)	≤20ms		
Release time (rated voltage)	≤20ms		
Operating frequency	18000 Ops/h		
Ambient temperature	-40~+55°C (Non-freezing condition)		
Ambient humidity	35%~85%RH		
Atmospheric pressure	86~106KPa		
Impact resistance	10G		
Vibration resistance	10~55Hz		
Electrical life (frequency: on for 1s, off for 1s)	≥10 <sup>5</sup> (1800 Ops/h)		
Mechanical life (frequency: 300 cycles/1 min)	≥10 <sup>7</sup> (18000 Ops/h)		
Weight per piece	About 19g		

## Relay Base and Accessories

Part Number	Product Description	Package Quantity	Specification
RER-J2C-XXXX	2C, 5A, with indicator and control button	20	--
0149-30-08A	Screw connection relay base, DIN rail mounting	10	RER-J2C-XXXX
0149-33-08E	Clamping connection relay base, DIN rail mounting	10	RER-J2C-XXXX
0149-32	Pastic retaining clip	10	0149-33-08E
0149-36	6~250VDC Volt.suppression component	10	0149-33-08E
0149-35-24	6-24VAC / DC LED indicator	10	0149-33-08E
0149-35-240	110-240VAC / DC LED indicator	10	0149-33-08E

## Performace Curve

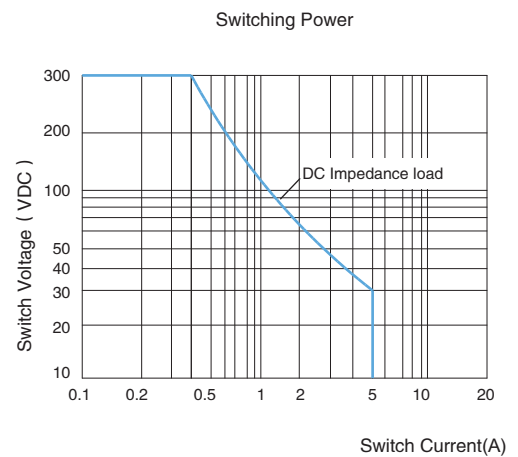
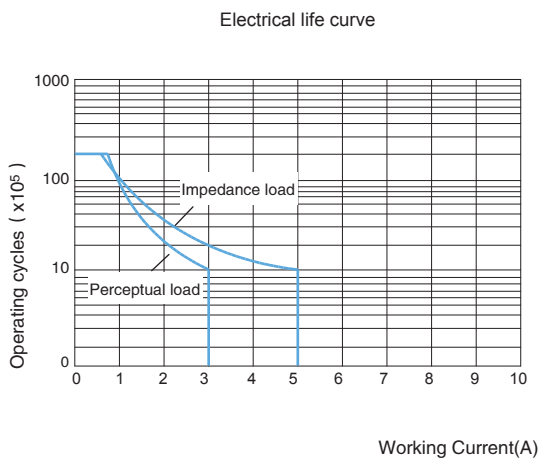

## Electrical Connections and Dimensions

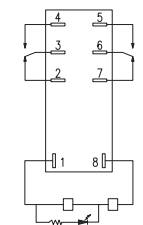
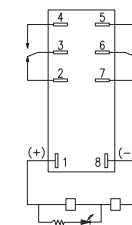
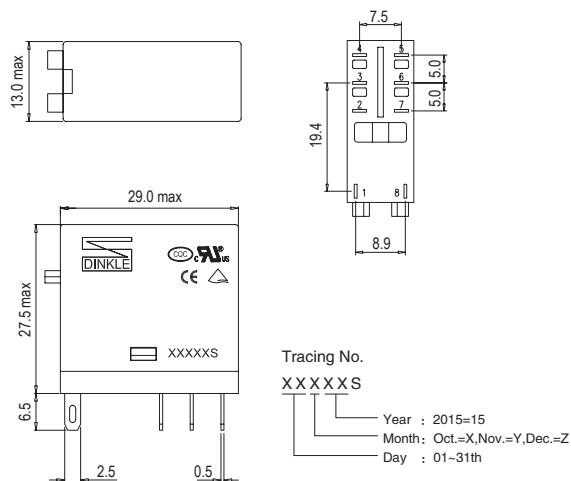



## Specifications of Relay Base



Part Number	0149-30-05A	0149-30-08A
Rated load current	16A	10A
Rated load voltage	300V	300V
Insulation resistance	2500V/s	2500V/s
Screw torque	0.8Nm	0.8Nm
External connection wire	20-14 / 0.5-2.5 (AWG/mm <sup>2</sup> )	20-14 / 0.5-2.5 (AWG/mm <sup>2</sup> )
Ambient temperature	-40~+85°C	-40~+85°C
Weight	About 22g	About 25g
Min. packing quantity	10pcs	10pcs
Mating part	RER-J1C	RER-J2C
<b>Accessories</b>		
Pastic retaining clip		
Metal retaining clip		
Electronic components		
DIN rail	TS-35	TS-35

## Dimensions

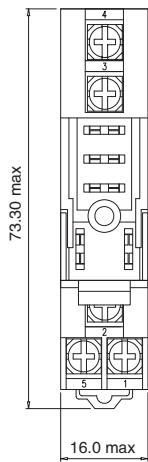

0149-30-05A

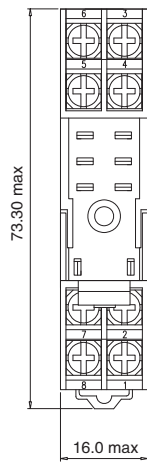

0149-30-08A

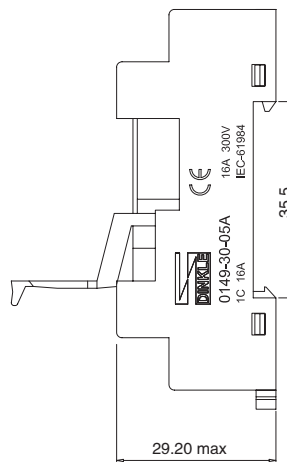

## Terminal Configuration and Internal Wiring Diagram

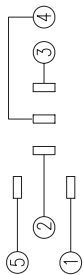

0149-30-05A

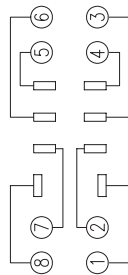

0149-30-08A

## Specifications of Relay Base



Part Number	0149-33-05E	0149-33-08E
Rated load current	16A	10A
Rated load voltage	300V	300V
Insulation resistance	2500V/s	2500V/s
Screw torque	1.0Nm	1.0Nm
External connection wire	20-14 / 0.5-2.5 (AWG/mm <sup>2</sup> )	20-14 / 0.5-2.5 (AWG/mm <sup>2</sup> )
Ambient temperature	-40~+85°C	-40~+85°C
Weight	About 33g	About 40g
Min. packing quantity	10pcs	10pcs
Mating part	RER-J1C	RER-J2C
<b>Accessories</b>		
Pastic retaining clip	0149-32 (@1pcs)	0149-32 (@1pcs)
Metal retaining clip		
Electronic components	0149-36 / 0149-35	0149-36 / 0149-35
DIN rail	TS-35	TS-35

## Dimensions

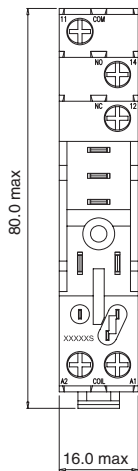

0149-33-05E

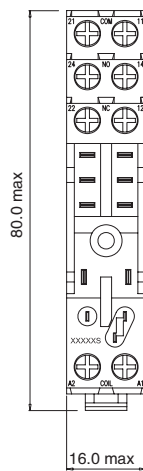

0149-33-08E

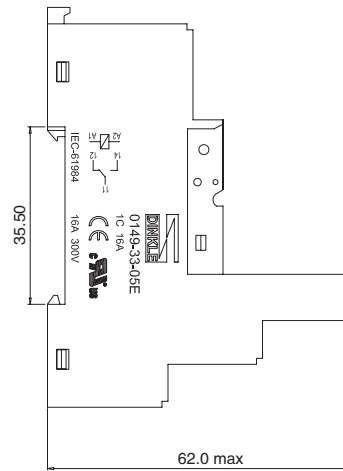

## Terminal configuration and internal wiring diagram

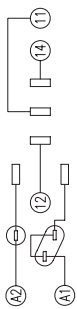

0149-33-05E

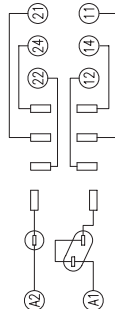

0149-33-08E

# Accessories



## Metal Retaining Clip

0149-11ES

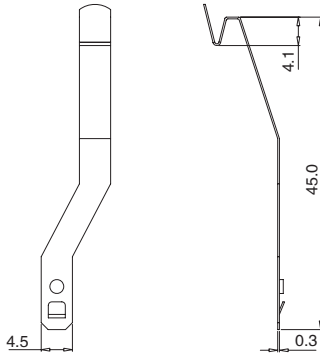
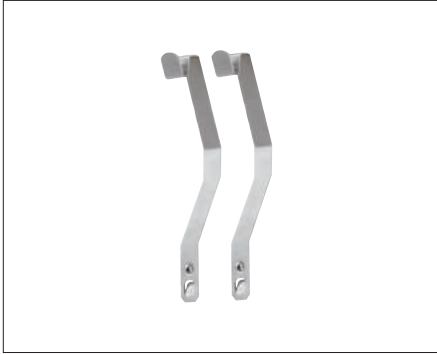

0149-11

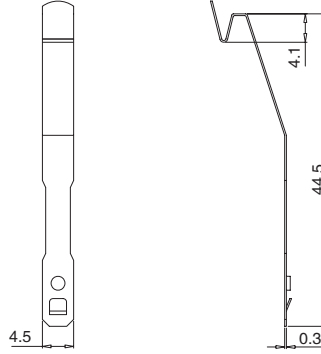

0149-21

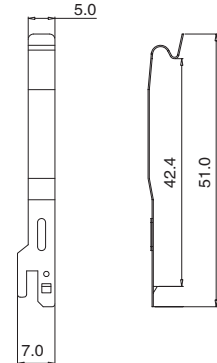

Part Number	Mating Part	Min. Packing Quantity
0149-11ES	0149-10-08A	20
0149-11	0149-10-14A	20
0149-21	0149-20-08A、0149-20-14A	20

## Plastic Retaining Clip

0149-14

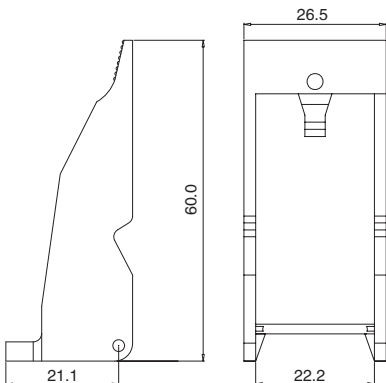

0149-32

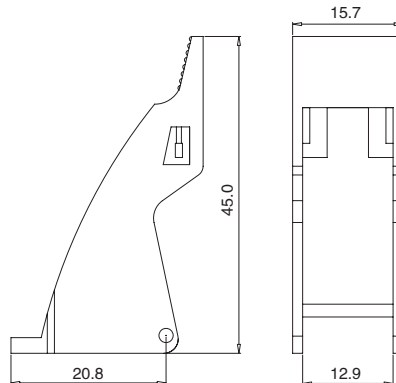

Part Number	Mating Part	Min. Packing Quantity
0149-14	0149-13-08E、0149-13-14E	5
0149-32	0149-33-05E、0149-33-08E	10

0149-36



0149-35-24



0149-35-240

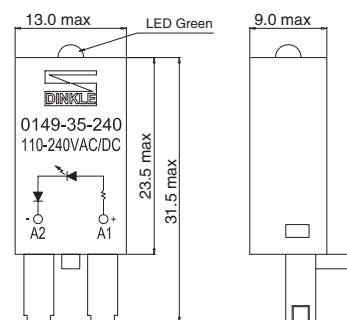
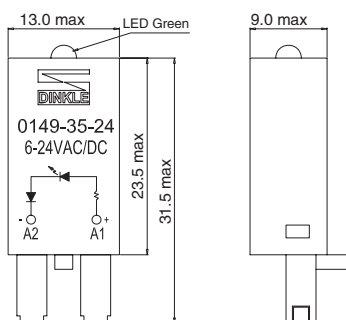
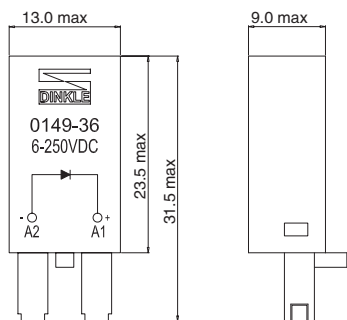

Part Number	Mating Part	Min. Packing Quantity
0149-36	0149-13-08E, 0149-13-14E, 0149-33-05E, 0149-33-08E	10
0149-35-24	0149-13-08E, 0149-13-14E, 0149-33-05E, 0149-33-08E	10
0149-35-240	0149-13-08E, 0149-13-14E, 0149-33-05E, 0149-33-08E	10

1 Pastic Retaining Clip

2 Electronic Components



## Contact information

### Contact type

Name	Symbol	Marking	Code
Normal open		NO	A
Normal close		NC	B
Common		COM	C

### Contact resistance

Contact resistance refers to the contribution to the total resistance of a system which is attributed to the contacting interfaces of contact points, the connected springs and the related circuit. The unit of measurement is ohm.

### Contact rating load

Generally, the specification of contact rating load is resistive load for sure until otherwise specify.

For instance: if a sample shown as 5A 230VAC/30VDC, which means maximum rated loading current is 5A and it's not allow to exceed 230 VAC or 30 VDC for voltage capacity.

### Contact material

As the relay is been used in a various industrial fields, it is important to select the appropriate material that could meet the needs for each application.

### Contact material information

Contact material	Material characteristics	Application	Spec. range
AgNi (Silver–Nickel)	<ul style="list-style-type: none"> <li>– Typical material of the contact</li> <li>– Good electric &amp; thermo conductivities</li> <li>– Superior affordability, no worry about contact ignition</li> <li>– Low contact conglutination</li> </ul>	Available for heavy loading; DC circuit or inductive loading.	Rated current <12A; impulse current <30A
AgSnO <sub>2</sub> (Silver–Tin)	<ul style="list-style-type: none"> <li>– Well affordability in high switching power</li> </ul>	Available for high switching power AC loading; inductive loading.	Rated current <30A; impulse current <50A
AgNi+Au (Silver–Nickel plated with gold)	<ul style="list-style-type: none"> <li>– Low current excited</li> <li>– Good electric &amp; thermo conductivities</li> <li>– Common ability against contact conglutination</li> <li>– No worry about oxidation</li> </ul>	Lamp load, inductive load and part of capacity load	High impulse current, max: 120A Min. conductive current < 5mA

## Coil information

### Release voltage

Release voltage means that when the relay is de-excited, the relay contact is normally switched and retained at the specified position, and no action is led.

### Operated voltage

Operated voltage refers to the minimum working voltage that the relay can safely operate, so that the relay contacts can be normally converted and maintained in proper position.

### Coil impedance and characteristics

The impedance of the coil can be measured with a resistance meter. The resistance is measured at a safety standard at 23°C. The tolerance is +/-10%. For the AC coils, the coil current and resistance do not match due to effect of self-inductance. At 230V, the coefficient of self-inductance will reach to 90H. When the coil is disconnected, the induced voltage from self-induction will affect the switching source.

### Protection circuit information

Protection type	Schematic diagram	Applicable coil	Response time	Application	Spec. range
Diode (Fly back)		Coil for DC	4 times of release time	Diode is used to the condition when damping released leads to transient energy. (to suppress counter emf)	Protective level III (2000V) up to 60VDC Protective level IV (4000V) from 61 to 250 VDC.
Diode+LED (Fly back + LED)		Coil for DC	4 times of release time		Protective level III (2000V) up to 60VDC Protective level IV (4000V) from 61 to 250 VDC.
RC (Sparkle absorber)		Coil for AC Contact for AC		Application for AC, driving to inductive load	Protective level III (2000V)
Bridge		Coil for both AC/DC	3 times of release time	Application for AC, it can be applied with AC or DC. Maximum voltage up to 250V.	Protective level II (1000V), max to 24V Protective level III (2000V) 25V~60V Protective level IV (1000V) 61V~250V