

P-620

栅板式端子 > 独立端子

下载日期:2026-06-15版次:1.2

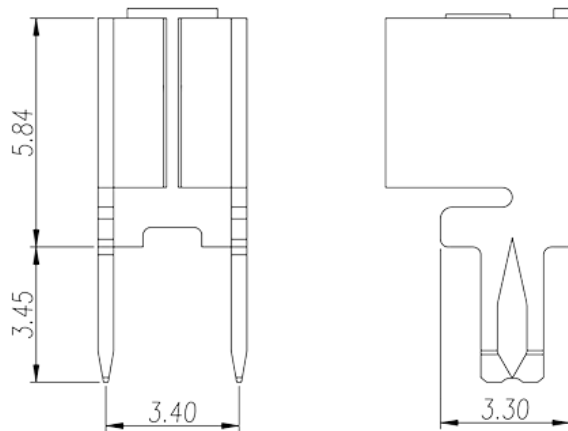

目录仅供参考，实际规格仍依照产品工程图面为准

产品介绍

Pitch : 3.40mm, 0.4x1.6mm, 20A

一般资讯

| | |
|------------------------|--|
| 产品概述 | Barrier terminal blocks, Quick terminal blocks |
| 产品类型 | Quick terminal blocks |
| 产品间距 (mm) | 3.40 |
| 引脚尺寸 (厚度___ x 宽度___mm) | 0.4x1.6 |

材料信息

| | |
|--------|--------------|
| 导体材料 | COPPER ALLOY |
| 导体表面镀层 | Tin PLATED |

连接数据-IEC

| | |
|----------|----|
| 额定电流 (A) | 20 |
|----------|----|

图面

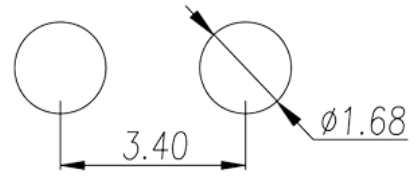
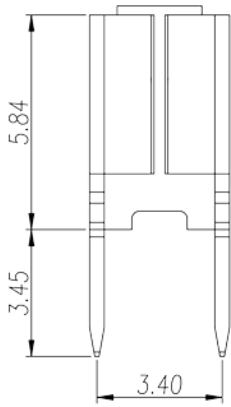

认证

