

P-872

Barriere-Anschlussblöcke > Drahtterminal

Date:2026-05-22Version:1.2

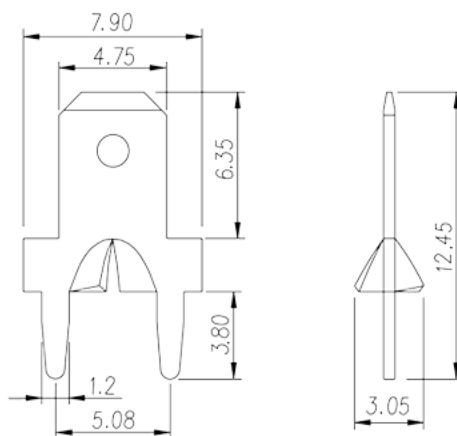
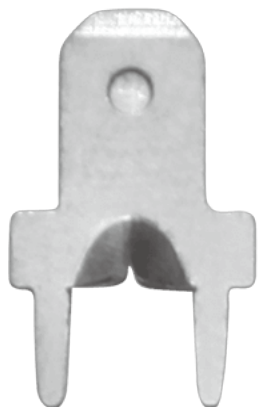

The web catalog is for reference only. Dinkle remains the right of product modification and engineering change of the design. The final product is made according to engineering drawing.

Produktbeschreibung

Pitch : 5.08mm, 0.5x1.2mm, 30A

Allgemeine Informationen

Kurzbeschreibung	Barrier terminal blocks, Quick terminal blocks
Kategorie	Quick terminal blocks
Pitch (mm)	5.08
Pin-Abmessungen (StärkexBreite)	0.5x1.2

Materialinformation

Leitermaterial	COPPER ALLOY
Oberflächenveredelung	Tin PLATED

Verbindungsdaten nach IEC

Nennstrom (A)	30
---------------	----

Zeichnungen

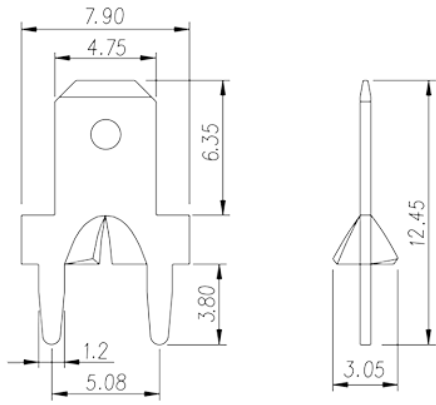

Zulassungen

