

# DK6P

DIN Rail Terminal Blocks > Screw Connection

Date:2026-04-29

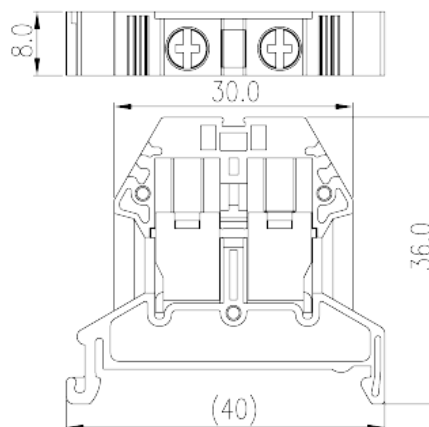

The web catalog is for reference only. Dinkle remains the right of product modification and engineering change of the design. The final product is made according to engineering drawing.

## Product Description

M4, 300V, 500A, Beige (default)

## General information

Short description	Single Level Feed-through Terminal Block
Category	Single Level Feed-through Terminal Block
Color	Beige (default)
Connection method	Screw Connection
Type of locking	Rail mounting
Length (mm)	40
Width (mm)	8
Height (mm)	36
Number of positions	□1P
Level	Single level
Connection points	2

## Material information

Insulation material	PA
Insulation material group	I
Flame retardant rating , compliant with UL94	V0

Insulation resistance	□500MΩ at DC 500V
Plating of conductor surface	Tin PLATED

## Connection data-IEC

Rated voltage (V)	500
Rated current (A)	41
Rated voltage (III/3)(V)	500
Rated impulse voltage (II/2)(KV)	6
Rated impulse voltage (III/2)(KV)	6
Rated impulse voltage (III/3)(KV)	6
Conductor cross section solid. min (mm <sup>2</sup> )	0.5
Conductor cross section solid.max (mm <sup>2</sup> )	10
Conductor cross section stranded. min (mm <sup>2</sup> )	0.5
Conductor cross section stranded. max (mm <sup>2</sup> )	6
Conductor cross section flexible, with min ferrule without plastic sleeve (mm <sup>2</sup> )	0.5
Conductor cross section flexible, with max ferrule without plastic sleeve (mm <sup>2</sup> )	6
Conductor cross section flexible, with min ferrule with plastic sleeve (mm <sup>2</sup> )	0.5
Conductor cross section flexible, with max ferrule with plastic sleeve (mm <sup>2</sup> )	6
2 conductors with same cross section, solid, min (mm <sup>2</sup> )	0.5
2 conductors with same cross section, solid, max (mm <sup>2</sup> )	6
2 conductors with same cross section, stranded, min (mm <sup>2</sup> )	0.5
2 conductors with same cross section, stranded, max (mm <sup>2</sup> )	4
2 conductors with same cross section flexible, with min ferrule without plastic sleeve (mm <sup>2</sup> )	0.5
2 conductors with same cross section flexible, with max ferrule without plastic sleeve (mm <sup>2</sup> )	4
2 conductors with same cross section flexible, min twin ferrules with plastic sleeve (mm <sup>2</sup> )	0.5
2 conductors with same cross section flexible, max twin ferrules with plastic sleeve (mm <sup>2</sup> )	4
Screw thread	M4
Slotted screwdriver size (Blade thickness x Width)(mm)	0.8x4
Philips screwdriver size	PH2

Rated torque (N.m)	1.2
Stripping Length (mm)	12~14
Mounting rail	TS-35N/TS-35/15N
End cover plate required	YES
Grounding connections	NO

## Connection data-UL

Rated voltage (UL/CUL Group B)(V)	300
Rated current (UL/CUL Group B)(A)	50
Rated voltage (UL/CUL Group C)(V)	300
Rated current (UL/CUL Group C)(A)	50
Min. solid wire connection (AWG) acc. to UL/CUL	20
Max. solid wire connection AWG acc. to UL/CUL	8
Min. stranded wire connection AWG acc. to UL/CUL	20
Max. stranded wire connection AWG acc. to UL/CUL	8

## Environment & Safety

Back of the hand protection (YES or NO)	YES
Finger protection (YES or NO)	YES
Operating temperature. max (°C)	120
Operating temperature. min (°C)	-40

## UL Recognized

Wire Range (Group B)(AWG)	20~8
Rated voltage (Group B)(V)	300
Rated current (Group B)(A)	50
Wire Range (Group C)(AWG)	20~8
Rated voltage (Group C)(V)	300
Rated current (Group C)(A)	50

## CUL Recognized

Wire Range (Group B)(AWG)	20~8
Rated voltage (Group B)(V)	300
Rated current (Group B)(A)	50
Wire Range (Group C)(AWG)	20~8

Rated voltage (Group C)(V)	300
Rated current (Group C)(A)	50

### VDE Approval

Wire Range (mm <sup>2</sup> )	0.5~6
Rated voltage (V)	500
Rated current (A)	41

### Explosion - proof Approvals

Wire Range (mm <sup>2</sup> )	0.5~6
Rated voltage (V)	500
Rated current (A)	41

### Drawings

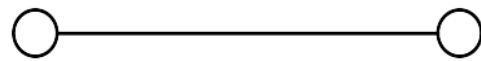
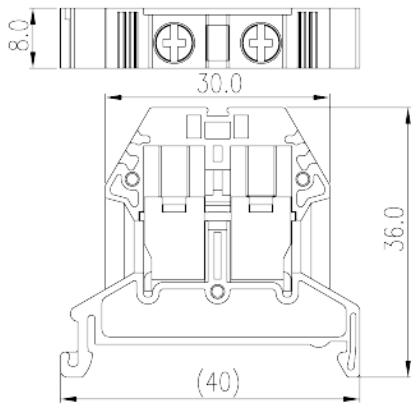

### Approvals

