

# EC381F-XXP

PCB Terminal Blocks &gt; PCB Connector-Plug

Date:2026-06-08Version:1.1

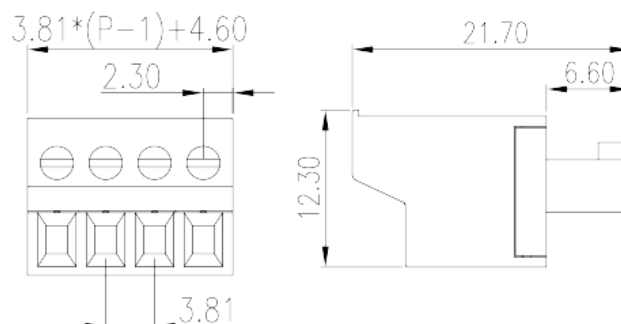
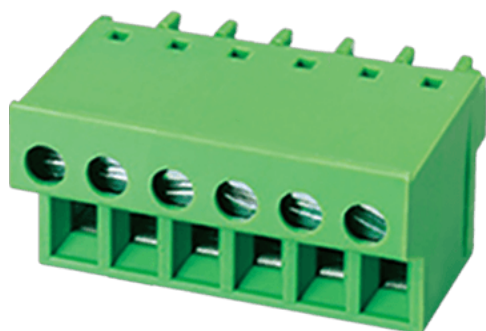

The web catalog is for reference only. Dinkle remains the right of product modification and engineering change of the design. The final product is made according to engineering drawing.

## Product Description

Pitch : 3.81 mm, 300V, 8A

## General information

Short description	PCB Connector – Plug, Front screw Connection
Category	PCB Connector – Plug
Pitch (mm)	3.81
Color	Green (default)
Connection method	Front screw Connection
Type of locking	Without
Length (mm)	$3.81*(P-1)+4.6$
Width (mm)	21.7
Height (mm)	12.3
Number of positions	02P~24P
Level	Single level

## Material information

Insulation material	PA
Insulation material group	I
Flame retardant rating , compliant with UL94	V0

Insulation resistance	□500MΩ at DC 500V
Conductor material	COPPER ALLOY
Plating of conductor surface	Tin PLATED

## Connection data-IEC

Rated voltage (V)	320
Rated current (A)	14
Rated voltage (II/2)(V)	320
Rated voltage (III/2) (V)	160
Rated voltage (III/3)(V)	160
Rated impulse voltage (II/2)(KV)	2.5
Rated impulse voltage (III/2)(KV)	2.5
Rated impulse voltage (III/3)(KV)	2.5
Conductor cross section solid. min (mm <sup>2</sup> )	0.2
Conductor cross section solid.max (mm <sup>2</sup> )	1.5
Conductor cross section stranded. min (mm <sup>2</sup> )	0.2
Conductor cross section stranded. max (mm <sup>2</sup> )	1.5
Conductor cross section flexible, with min ferrule without plastic sleeve (mm <sup>2</sup> )	0.25
Conductor cross section flexible, with max ferrule without plastic sleeve (mm <sup>2</sup> )	0.75
Conductor cross section flexible, with min ferrule with plastic sleeve (mm <sup>2</sup> )	0.25
Conductor cross section flexible, with max ferrule with plastic sleeve (mm <sup>2</sup> )	0.5
2 conductors with same cross section, solid, min (mm <sup>2</sup> )	0.2
2 conductors with same cross section, solid, max (mm <sup>2</sup> )	0.75
2 conductors with same cross section, stranded, min (mm <sup>2</sup> )	0.2
2 conductors with same cross section, stranded, max (mm <sup>2</sup> )	0.75
2 conductors with same cross section flexible, with min ferrule without plastic sleeve (mm <sup>2</sup> )	0.5
2 conductors with same cross section flexible, with max ferrule without plastic sleeve (mm <sup>2</sup> )	0.5
2 conductors with same cross section flexible, min twin ferrules with plastic sleeve (mm <sup>2</sup> )	0.5
2 conductors with same cross section flexible, max twin ferrules with plastic sleeve (mm <sup>2</sup> )	0.5

Screw thread	M2
Slotted screwdriver size (Blade thickness x Width)(mm)	0.4x2.5
Philips screwdriver size	PH0
Rated torque (N.m)	0.3
Stripping Length (mm)	7~8

## Connection data-UL

Rated voltage (UL/CUL Group B)(V)	300
Rated current (UL/CUL Group B)(A)	8
Rated voltage (UL/CUL Group D)(V)	300
Rated current (UL/CUL Group D)(A)	8
Min. solid wire connection (AWG) acc. to UL/CUL	30
Max. solid wire connection AWG acc. to UL/CUL	14
Min. stranded wire connection AWG acc. to UL/CUL	30
Max. stranded wire connection AWG acc. to UL/CUL	14

## Environment & Safety

Finger protection (YES or NO)	YES
Operating temperature. max (°C)	120
Operating temperature. min (°C)	-40

## UL Recognized

Wire Range (Group B)(AWG)	30~14
Rated voltage (Group B)(V)	300
Rated current (Group B)(A)	8
Wire Range (Group D)(AWG)	30~14
Rated voltage (Group D)(V)	300
Rated current (Group D)(A)	8

## CUL Recognized

Wire Range (Group B)(AWG)	30~14
Rated voltage (Group B)(V)	300
Rated current (Group B)(A)	8
Wire Ranget (Group D)(AWG)	30~14
Rated voltage (Group D)(V)	300

Rated current (Group D)(A)	8
----------------------------	---

## VDE Approval

Wire Range (mm <sup>2</sup> )	0.2~1.5
Rated voltage (V)	320
Rated current (A)	14

## Drawings

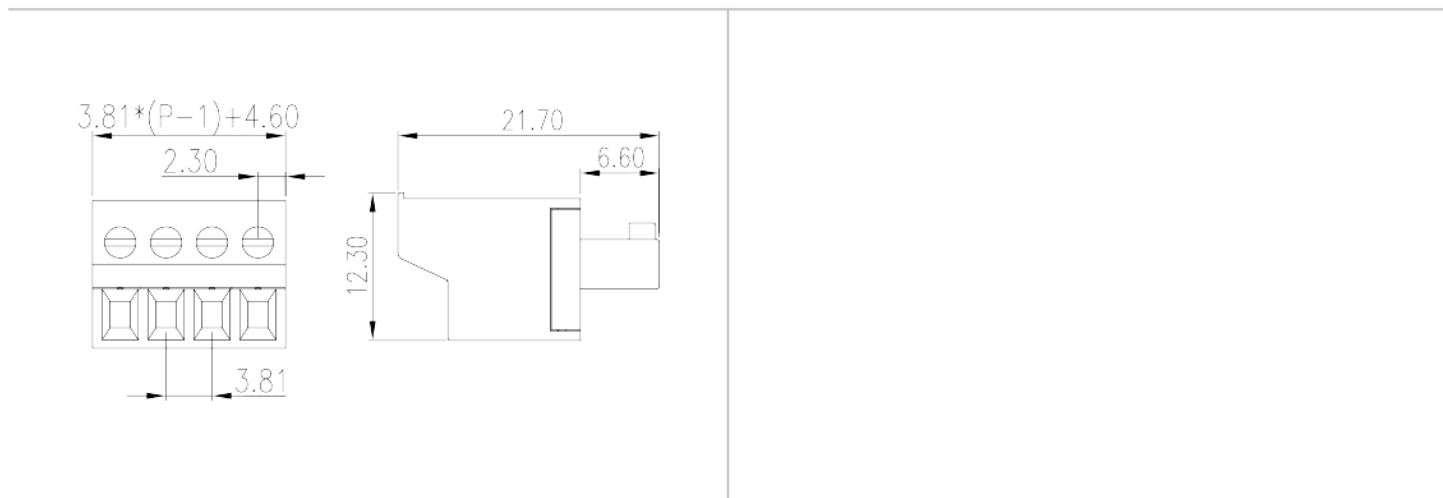

## Approvals

