

AK10

DIN Rail Terminal Blocks > Spring Clamp Connection

Date:2026-06-14Version:1.1

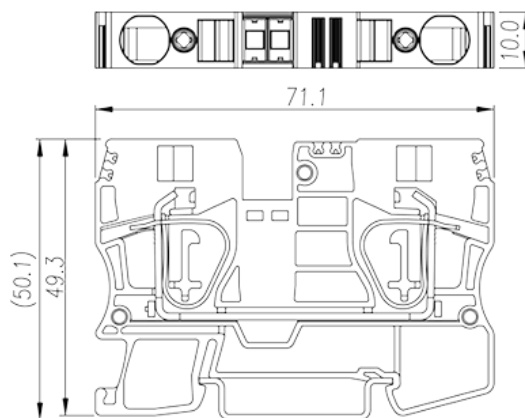
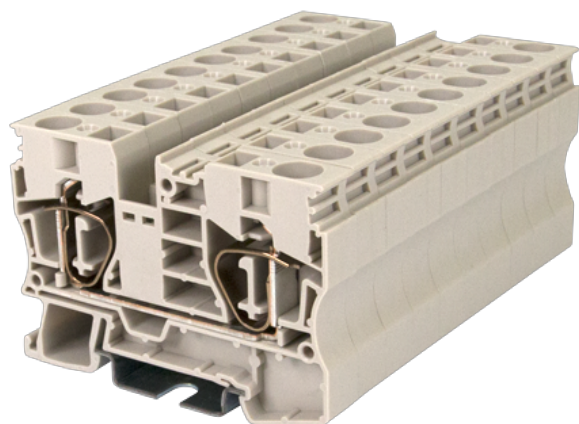

The web catalog is for reference only. Dinkle remains the right of product modification and engineering change of the design. The final product is made according to engineering drawing.

Product Description

600V, 51A, Beige (default)

General information

Short description	DIN Rail terminal blocks, Feed through terminal blocks
Category	Feed through terminal blocks
Color	Beige (default)
Connection method	Spring Clamp Connection
Type of locking	Rail Mounting
Length (mm)	71.1
Width (mm)	10
Height (mm)	49.3
Level	Single level
Connection points	2

Material information

Insulation material	PA
Insulation material group	I
Flame retardant rating , compliant with UL94	V0

Insulation resistance

 $\geq 500M\Omega$ at DC 500V

Connection data-IEC

Rated voltage (V)	800
Rated current (A)	57
Rated voltage (III/3)(V)	800
Rated impulse voltage (II/2)(KV)	8
Rated impulse voltage (III/2)(KV)	8
Rated impulse voltage (III/3)(KV)	8
Conductor cross section solid. min (mm ²)	1.5
Conductor cross section solid.max (mm ²)	10
Conductor cross section stranded. min (mm ²)	1.5
Conductor cross section stranded. max (mm ²)	10
Conductor cross section flexible, with min ferrule without plastic sleeve (mm ²)	1.5
Conductor cross section flexible, with max ferrule without plastic sleeve (mm ²)	10
Conductor cross section flexible, with min ferrule with plastic sleeve (mm ²)	1.5
Conductor cross section flexible, with max ferrule with plastic sleeve (mm ²)	10
2 conductors with same cross section flexible, min twin ferrules with plastic sleeve (mm ²)	1.5
2 conductors with same cross section flexible, max twin ferrules with plastic sleeve (mm ²)	2.5
Slotted screwdriver size (Blade thickness x Width)(mm)	1.0x5.5
Stripping Length (mm)	18
Mounting rail	TS-35
End cover plate required	YES
Grounding connections	NO

Connection data-UL

Rated voltage (UL/CUL Group B)(V)	600
Rated current (UL/CUL Group B)(A)	51
Rated voltage (UL/CUL Group C)(V)	600
Rated current (UL/CUL Group C)(A)	51
Min. solid wire connection (AWG) acc. to UL/CUL	24
Max. solid wire connection AWG acc. to UL/CUL	6

Min. stranded wire connection AWG acc. to UL/CUL	24
Max. stranded wire connection AWG acc. to UL/CUL	6

Environment & Safety

Back of the hand protection (YES or NO)	YES
Finger protection (YES or NO)	YES
Operating temperature. max (°C)	120
Operating temperature. min (°C)	-40

UL Recognized

Wire Range (Group B)(AWG)	24~6
Rated voltage (Group B)(V)	600
Rated current (Group B)(A)	51
Wire Range (Group C)(AWG)	24~6
Rated voltage (Group C)(V)	600
Rated current (Group C)(A)	51

CUL Recognized

Wire Range (Group B)(AWG)	24~6
Rated voltage (Group B)(V)	600
Rated current (Group B)(A)	51
Wire Range (Group C)(AWG)	24~6
Rated voltage (Group C)(V)	600
Rated current (Group C)(A)	51

VDE Approval

Wire Range (mm ²)	1.5~10
Rated voltage (V)	800
Rated current (A)	57

Drawings

--	--

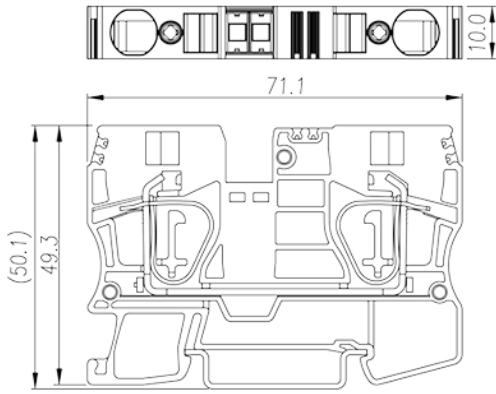

Approvals

