

ED130F-XXP

PCB Terminal Blocks > PCB Connector-Plug

Date:2026-06-27Version:1.1

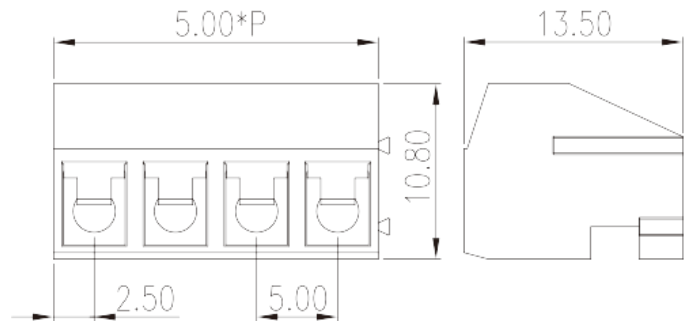

The web catalog is for reference only. Dinkle remains the right of product modification and engineering change of the design. The final product is made according to engineering drawing.

Product Description

Pitch : 5.00 mm, 300V, 7A

General information

Short description	PCB Connector – Plug, Wire protector type
Category	PCB Connector – Plug
Pitch (mm)	5.00
Color	Blue (default)
Connection method	Wire Protector Type
Type of locking	Without
Length (mm)	5.00*P
Width (mm)	13.5
Height (mm)	10.8
Number of positions	02P~03P
Level	Single level

Material information

Insulation material	PBT
Insulation material group	IIIa
Flame retardant rating , compliant with UL94	V0

Insulation resistance	□1000MΩ at DC 500V
Conductor material	COPPER ALLOY
Plating of conductor surface	Tin PLATED

Connection data-IEC

Rated voltage (V)	250
Rated current (A)	12
Rated voltage (II/2)(V)	400
Rated voltage (III/2) (V)	320
Rated voltage (III/3)(V)	250
Rated impulse voltage (II/2)(KV)	4
Rated impulse voltage (III/2)(KV)	4
Rated impulse voltage (III/3)(KV)	4
Conductor cross section solid. min (mm ²)	0.5
Conductor cross section solid.max (mm ²)	1.5
Conductor cross section stranded. min (mm ²)	0.5
Conductor cross section stranded. max (mm ²)	1.5
Conductor cross section flexible, with min ferrule without plastic sleeve (mm ²)	0.34
Conductor cross section flexible, with max ferrule without plastic sleeve (mm ²)	1
Conductor cross section flexible, with min ferrule with plastic sleeve (mm ²)	0.34
Conductor cross section flexible, with max ferrule with plastic sleeve (mm ²)	1
2 conductors with same cross section, solid, max (mm ²)	1
2 conductors with same cross section, stranded, max (mm ²)	1
2 conductors with same cross section flexible, with min ferrule without plastic sleeve (mm ²)	0.25
2 conductors with same cross section flexible, with max ferrule without plastic sleeve (mm ²)	0.34
2 conductors with same cross section flexible, min twin ferrules with plastic sleeve (mm ²)	0.5
2 conductors with same cross section flexible, max twin ferrules with plastic sleeve (mm ²)	0.5
Screw thread	M2.5
Slotted screwdriver size (Blade thickness x Width)(mm)	0.6x3.5
Philips screwdriver size	PH1

Rated torque (N.m)	0.3
Stripping Length (mm)	5~6

Connection data-UL

Rated voltage (UL/CUL Group B)(V)	300
Rated current (UL/CUL Group B)(A)	7
Rated voltage (UL/CUL Group D)(V)	300
Rated current (UL/CUL Group D)(A)	7
Min. solid wire connection (AWG) acc. to UL/CUL	22
Max. solid wire connection AWG acc. to UL/CUL	14
Min. stranded wire connection AWG acc. to UL/CUL	22
Max. stranded wire connection AWG acc. to UL/CUL	14

Environment & Safety

Finger protection (YES or NO)	YES
Operating temperature. max (°C)	120
Operating temperature. min (°C)	-40

UL Recognized

Wire Range (Group B)(AWG)	22~14
Rated voltage (Group B)(V)	300
Rated current (Group B)(A)	7
Wire Range (Group D)(AWG)	22~14
Rated voltage (Group D)(V)	300
Rated current (Group D)(A)	7

CUL Recognized

Wire Range (Group B)(AWG)	22~14
Rated voltage (Group B)(V)	300
Rated current (Group B)(A)	7
Wire Ranget (Group D)(AWG)	22~14
Rated voltage (Group D)(V)	300
Rated current (Group D)(A)	7

Drawings

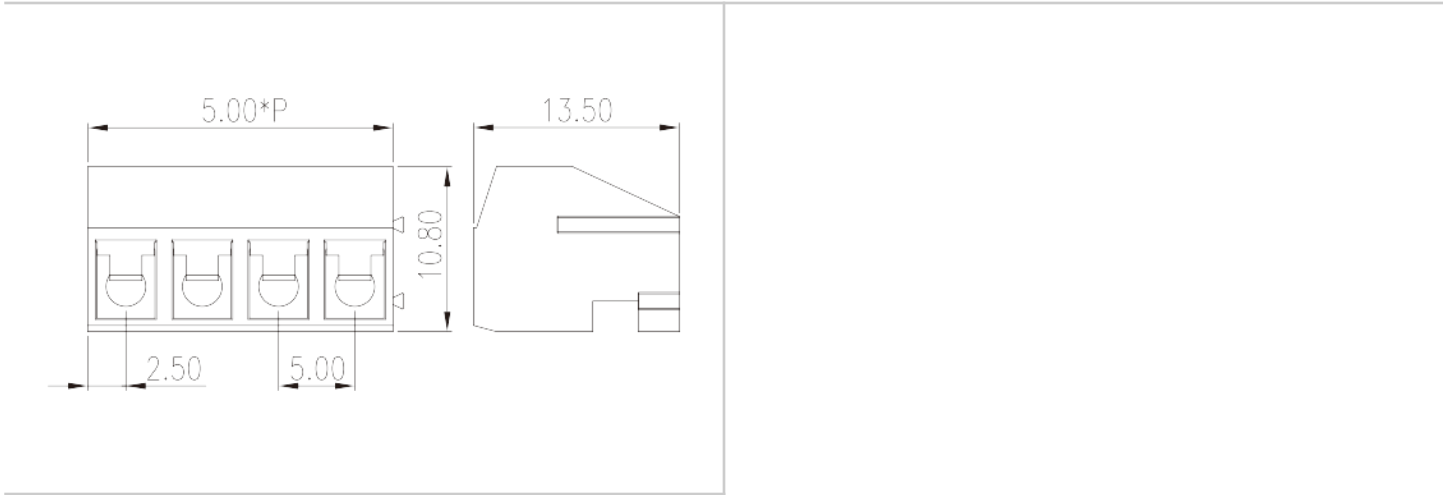

Approvals

