

# 0221-39XXL

PCB Terminal Blocks &gt; PCB Connector-Socket

Date:2026-04-08Version:V1

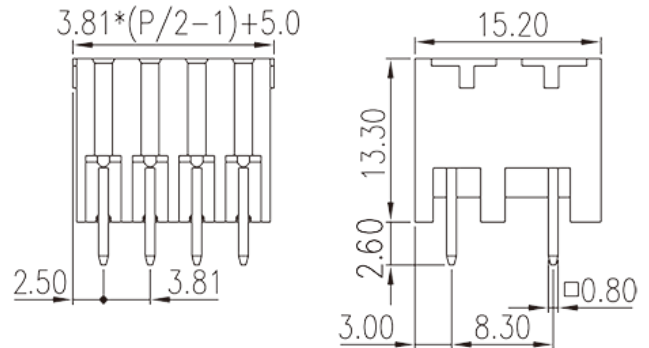

The web catalog is for reference only. Dinkle remains the right of product modification and engineering change of the design. The final product is made according to engineering drawing.

## Product Description

Pitch : 3.81 mm, 300V, 8A

## General information

Short description	PCB Connector-Socket, Reflow soldering
Category	PCB Connector-Socket
Pitch (mm)	3.81
Color	Black (default)
Type of locking	Without
Soldering method	Reflow Soldering (Temperature condition according to standard IPC/JEDEC J-STD-020E)
Length (mm)	$3.81 * (P/2 - 1) + 5.0$
Width (mm)	15.2
Height (mm)	13.3
Pin demensions (Thickness x Width)(mm)	0.8x0.8
PCB hole diameter (mm)	1.3~1.4
Number of positions	04P~48P
Level	Double level

## Material information

Insulation material	HIGH-TEMPERATURE PLASTICS
Insulation material group	I
Flame retardant rating , compliant with UL94	V0
Insulation resistance	□500MΩ at DC 500V
Conductor material	COPPER ALLOY
Plating of conductor surface	Tin PLATED
MSL	2

### Connection data-IEC

Rated voltage (V)	320
Rated current (A)	8
Rated voltage (II/2)(V)	320
Rated voltage (III/2) (V)	160
Rated voltage (III/3)(V)	160
Rated impulse voltage (II/2)(KV)	2.5
Rated impulse voltage (III/2)(KV)	2.5
Rated impulse voltage (III/3)(KV)	2.5

### Connection data-UL

Rated voltage (UL/CUL Group B)(V)	300
Rated current (UL/CUL Group B)(A)	8

### Environment & Safety

Finger protection (YES or NO)	YES
Operating temperature. max (°C)	120
Operating temperature. min (°C)	-40

### UL Recognized

Rated voltage (Group B)(V)	300
Rated current (Group B)(A)	8

### CUL Recognized

Rated voltage (Group B)(V)	300
Rated current (Group B)(A)	8

## Drawings

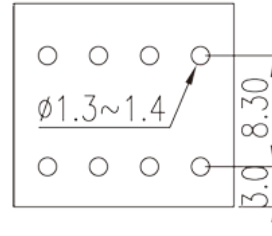
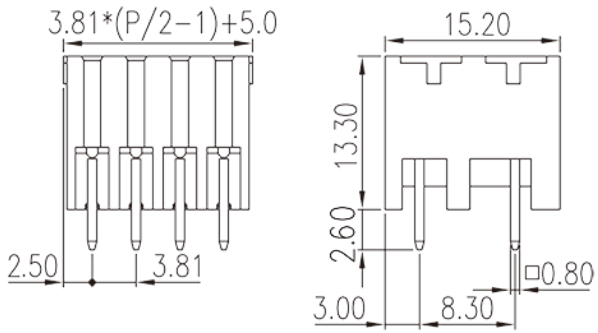

## Approvals

