

# 0156-1BXX-BK

PCB Terminal Blocks &gt; PCB Connector-Plug

Date:2026-05-08Version:1.1

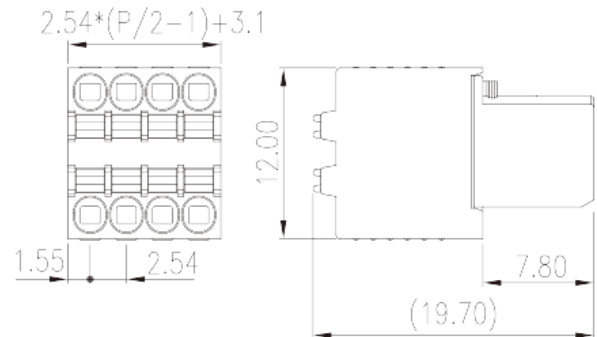

The web catalog is for reference only. Dinkle remains the right of product modification and engineering change of the design. The final product is made according to engineering drawing.

## Product Description

Pitch : 2.54 mm, 150V, 5A

## General information

Short description	PCB Connector – Plug, Push-in Design
Category	PCB Connector – Plug
Pitch (mm)	2.54
Color	Black (default)
Connection method	Push in Design
Type of locking	Without
Length (mm)	$2.54*(P/2-1)+3.1$
Width (mm)	12
Height (mm)	19.7
Number of positions	06P~44P
Level	Double level

## Material information

Insulation material	PA
Insulation material group	I
Flame retardant rating , compliant with UL94	V0

Insulation resistance	□500MΩ at DC 500V
Conductor material	COPPER ALLOY
Plating of conductor surface	Tin PLATED

## Connection data-IEC

Rated voltage (V)	320
Rated current (A)	6
Rated voltage (II/2)(V)	320
Rated voltage (III/2) (V)	160
Rated voltage (III/3)(V)	160
Rated impulse voltage (II/2)(KV)	2.5
Rated impulse voltage (III/2)(KV)	2.5
Rated impulse voltage (III/3)(KV)	2.5
Conductor cross section solid. min (mm <sup>2</sup> )	0.2
Conductor cross section solid.max (mm <sup>2</sup> )	0.5
Conductor cross section stranded. min (mm <sup>2</sup> )	0.2
Conductor cross section stranded. max (mm <sup>2</sup> )	0.5
Conductor cross section flexible, with min ferrule without plastic sleeve (mm <sup>2</sup> )	0.25
Conductor cross section flexible, with max ferrule without plastic sleeve (mm <sup>2</sup> )	0.5
Conductor cross section flexible, with min ferrule with plastic sleeve (mm <sup>2</sup> )	0.25
Conductor cross section flexible, with max ferrule with plastic sleeve (mm <sup>2</sup> )	0.34
Stripping Length (mm)	7~8

## Connection data-UL

Rated voltage (UL/CUL Group B)(V)	150
Rated current (UL/CUL Group B)(A)	5
Min. solid wire connection (AWG) acc. to UL/CUL	30
Max. solid wire connection AWG acc. to UL/CUL	20
Min. stranded wire connection AWG acc. to UL/CUL	30
Max. stranded wire connection AWG acc. to UL/CUL	20

## Environment & Safety

Finger protection (YES or NO)	YES
-------------------------------	-----

Operating temperature. max (°C)	120
Operating temperature. min (°C)	-40

### UL Recognized

Wire Range (Group B)(AWG)	30~20
Rated voltage (Group B)(V)	150
Rated current (Group B)(A)	5

### CUL Recognized

Wire Range (Group B)(AWG)	30~20
Rated voltage (Group B)(V)	150
Rated current (Group B)(A)	5

### Drawings

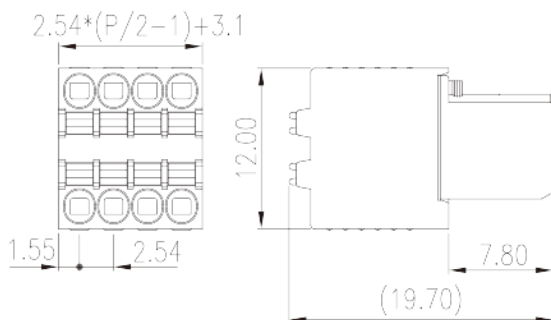

### Approvals

