

# DP6N-TN

DIN Rail Terminal Blocks &gt; Push-in Design

Date:2026-04-30Version:V1.1

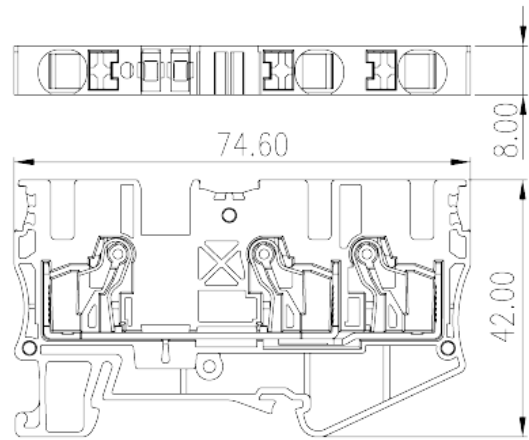
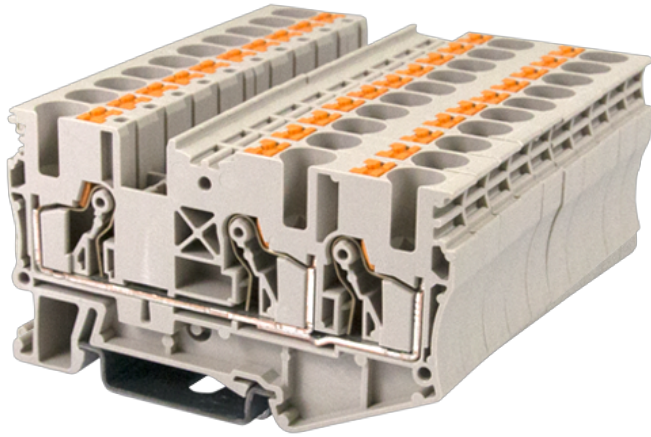

The web catalog is for reference only. Dinkle remains the right of product modification and engineering change of the design. The final product is made according to engineering drawing.

## Product Description

600V, 40A, Beige (default)

## General information

Short description	Single level Feed-Through Terminal Block, Push-in Design
Category	Single level Feed Through Terminal Block
Color	Beige (default)
Connection method	Push-in Design
Type of locking	Rail Mounting
Length (mm)	74.6
Width (mm)	8
Height (mm)	42
Number of positions	≥1P
Level	Single level
Connection points	3

## Material information

Insulation material	PA
Insulation material group	I

Flame retardant rating , compliant with UL94	V0
Insulation resistance	≥500MΩ at DC 500V

## Connection data-IEC

Rated voltage (V)	1000
Rated current (A)	41
Rated voltage (III/3)(V)	1000
Rated impulse voltage (III/3)(KV)	8
Conductor cross section solid. min (mm <sup>2</sup> )	0.5
Conductor cross section solid.max (mm <sup>2</sup> )	10
Conductor cross section stranded. min (mm <sup>2</sup> )	0.5
Conductor cross section stranded. max (mm <sup>2</sup> )	6
Conductor cross section flexible, with min ferrule without plastic sleeve (mm <sup>2</sup> )	0.5
Conductor cross section flexible, with max ferrule without plastic sleeve (mm <sup>2</sup> )	6
Conductor cross section flexible, with min ferrule with plastic sleeve (mm <sup>2</sup> )	0.5
Conductor cross section flexible, with max ferrule with plastic sleeve (mm <sup>2</sup> )	6
2 conductors with same cross section flexible, min twin ferrules with plastic sleeve (mm <sup>2</sup> )	0.5
2 conductors with same cross section flexible, max twin ferrules with plastic sleeve (mm <sup>2</sup> )	1.5
Slotted screwdriver size (Blade thickness x Width)(mm)	0.8x4.0
Stripping Length (mm)	12
Mounting rail	TS-35、TS-35/15
End cover plate required	YES
Grounding connections	NO

## Connection data-UL

Rated voltage (UL/CUL Group B)(V)	600
Rated current (UL/CUL Group B)(A)	40
Rated voltage (UL/CUL Group C)(V)	600
Rated current (UL/CUL Group C)(A)	40
Min. solid wire connection (AWG) acc. to UL/CUL	20
Max. solid wire connection AWG acc. to UL/CUL	8
Min. stranded wire connection AWG acc. to UL/CUL	20

Max. stranded wire connection AWG acc. to UL/CUL

8

## Environment & Safety

Back of the hand protection (YES or NO)	YES
Finger protection (YES or NO)	YES
Operating temperature. max (°C)	120
Operating temperature. min (°C)	-40

## UL Recognized

Wire Range (Group B)(AWG)	20~8
Rated voltage (Group B)(V)	600
Rated current (Group B)(A)	40
Wire Range (Group C)(AWG)	20~8
Rated voltage (Group C)(V)	600
Rated current (Group C)(A)	40

## CUL Recognized

Wire Range (Group B)(AWG)	20~8
Rated voltage (Group B)(V)	600
Rated current (Group B)(A)	40
Wire Range (Group C)(AWG)	20~8
Rated voltage (Group C)(V)	600
Rated current (Group C)(A)	40

## Drawings

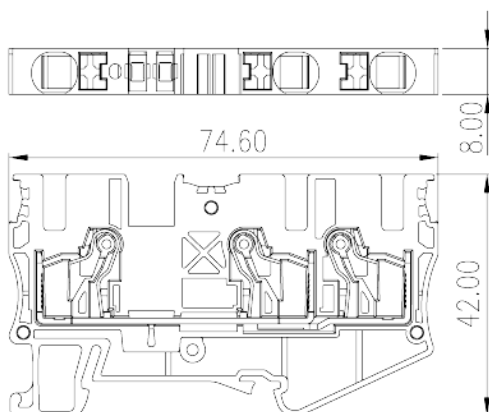

## Approvals

---

