

0191-02XXC

PCB Terminal Blocks > PCB Connector-Plug

Date:2026-07-06

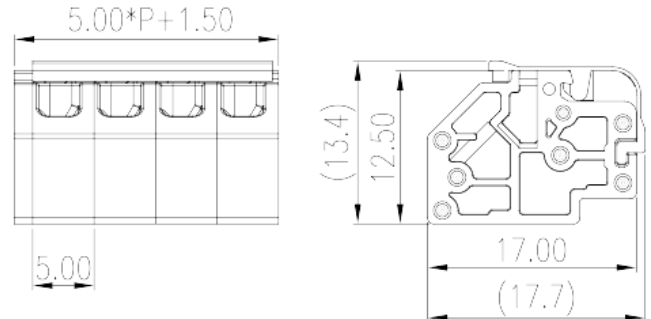

The web catalog is for reference only. Dinkle remains the right of product modification and engineering change of the design. The final product is made according to engineering drawing.

Product Description

Pitch : 5.00mm, 300V, 2A

General information

Short description	PCB Connector – Plug, Push-in Design
Category	PCB Connector – Plug
Pitch (mm)	5.00
Color	Black (default)
Connection method	Push in Design
Type of locking	Without
Length (mm)	5.00*P+1.5
Width (mm)	17.7
Height (mm)	13.4
Number of positions	02P~20P
Level	Single level

Material information

Insulation material	PA
Insulation material group	I
Flame retardant rating , compliant with UL94	V0

Insulation resistance	□500MΩ at DC 500V
Conductor material	STAINLESS STEEL
Plating of conductor surface	Tin PLATED

Connection data-IEC

Rated voltage (V)	320
Rated current (A)	4
Rated voltage (II/2)(V)	630
Rated voltage (III/2) (V)	320
Rated voltage (III/3)(V)	250
Rated impulse voltage (II/2)(KV)	4
Rated impulse voltage (III/2)(KV)	4
Rated impulse voltage (III/3)(KV)	4
Conductor cross section solid. min (mm ²)	0.5
Conductor cross section solid.max (mm ²)	1.5
Conductor cross section stranded. min (mm ²)	0.5
Conductor cross section stranded. max (mm ²)	1.5
Conductor cross section flexible, with min ferrule without plastic sleeve (mm ²)	0.5
Conductor cross section flexible, with max ferrule without plastic sleeve (mm ²)	1.5
Conductor cross section flexible, with min ferrule with plastic sleeve (mm ²)	0.5
Conductor cross section flexible, with max ferrule with plastic sleeve (mm ²)	1.5
Stripping Length (mm)	8~9

Connection data-UL

Rated voltage (UL/CUL Group B)(V)	300
Rated current (UL/CUL Group B)(A)	2
Rated voltage (UL/CUL Group D)(V)	300
Rated current (UL/CUL Group D)(A)	2
Min. solid wire connection (AWG) acc. to UL/CUL	28
Max. solid wire connection AWG acc. to UL/CUL	16
Min. stranded wire connection AWG acc. to UL/CUL	28
Max. stranded wire connection AWG acc. to UL/CUL	16

Environment & Safety

Finger protection (YES or NO)	YES
Operating temperature. max (°C)	120
Operating temperature. min (°C)	-40

UL Recognized

Wire Range (Group B)(AWG)	28~16
Rated voltage (Group B)(V)	300
Rated current (Group B)(A)	2
Wire Range (Group D)(AWG)	28~16
Rated voltage (Group D)(V)	300
Rated current (Group D)(A)	2

CUL Recognized

Wire Range (Group B)(AWG)	28~16
Rated voltage (Group B)(V)	300
Rated current (Group B)(A)	2
Wire Ranget (Group D)(AWG)	28~16
Rated voltage (Group D)(V)	300
Rated current (Group D)(A)	2

Drawings

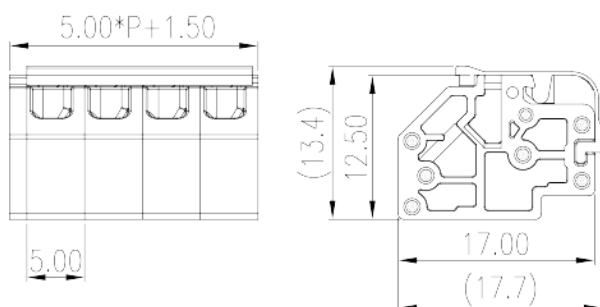

Approvals

