

2EHDV-XXPWR

PCB Terminal Blocks > In tape-on-reel packing

Date:2026-06-27Version:V1

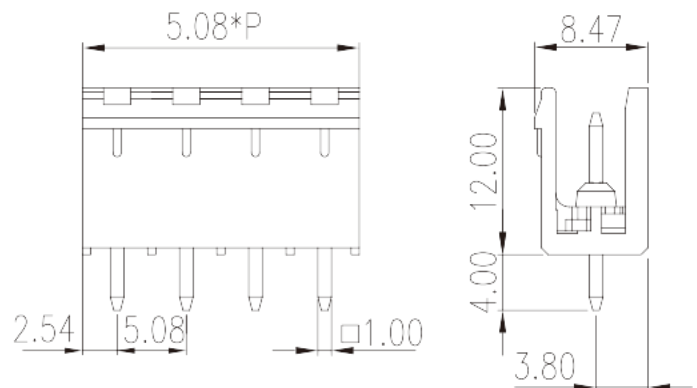
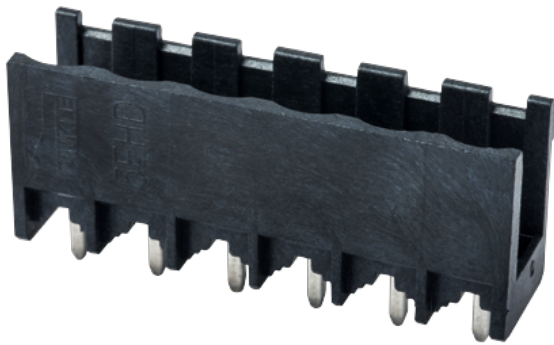

The web catalog is for reference only. Dinkle remains the right of product modification and engineering change of the design. The final product is made according to engineering drawing.

Product Description

Pitch: 5.08 mm, 300V, 20A

General information

Short description	PCB Connector – Socket, Wave soldering
Category	PCB Connector – Socket
Pitch (mm)	5.08
Color	Black (default)
Type of locking	Without
Soldering method	Wave soldering
Length (mm)	$5.08*(P-1)+5.08$
Width (mm)	8.47
Height (mm)	12
Pin demensions (Thickness x Width)(mm)	1.0x1.0
PCB hole diameter (mm)	1.6~1.7
Number of positions	02P~24P
Level	Single level

Material information

Insulation material	PA
---------------------	----

Insulation material group	I
Flame retardant rating , compliant with UL94	V0
Insulation resistance	□500MΩ at DC 500V
Conductor material	COPPER ALLOY
Plating of conductor surface	Tin PLATED

Connection data-IEC

Rated voltage (V)	630
Rated current (A)	18
Rated voltage (II/2)(V)	630
Rated voltage (III/2) (V)	320
Rated voltage (III/3)(V)	320
Rated impulse voltage (II/2)(KV)	4
Rated impulse voltage (III/2)(KV)	4
Rated impulse voltage (III/3)(KV)	4

Connection data-UL

Rated voltage (UL/CUL Group B)(V)	300
Rated current (UL/CUL Group B)(A)	20
Rated voltage (UL/CUL Group D)(V)	300
Rated current (UL/CUL Group D)(A)	10

Environment & Safety

Finger protection (YES or NO)	YES
Operating temperature. max (°C)	120
Operating temperature. min (°C)	-40

UL Recognized

Rated voltage (Group B)(V)	300
Rated current (Group B)(A)	20
Rated voltage (Group D)(V)	300
Rated current (Group D)(A)	10

CUL Recognized

Rated voltage (Group B)(V)	300
----------------------------	-----

Rated current (Group B)(A)	20
Rated voltage (Group D)(V)	300
Rated current (Group D)(A)	10

Drawings

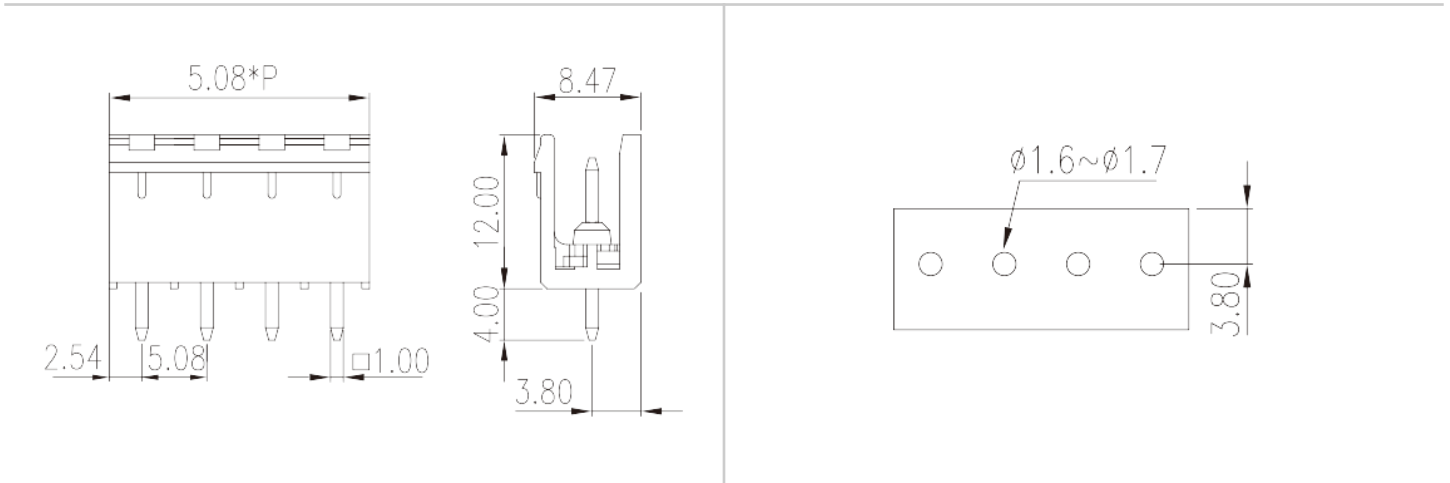

Approvals

