

DKU15

NEMA Terminal Blocks > Rail Mounting

Date:2026-07-01

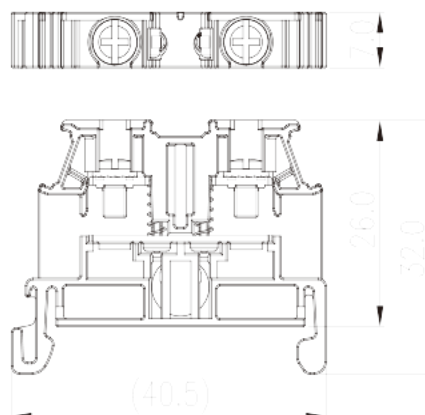
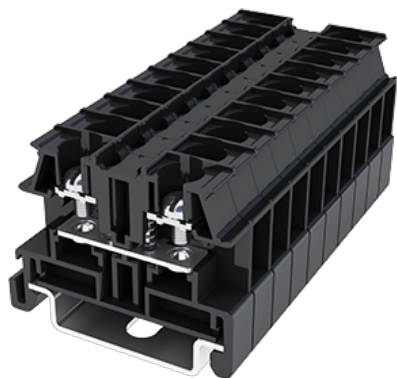

The web catalog is for reference only. Dinkle remains the right of product modification and engineering change of the design. The final product is made according to engineering drawing.

Product Description

M3, 600V, 15/20A

General information

Short description	Feed-Through single level, Screw Connection
Category	Feed-Through single level
Pitch (mm)	7
Color	Refer to drawing
Connection method	Screw Connection
Type of locking	Rail mounting
Length (mm)	40.5
Width (mm)	7
Height (mm)	33.5 (TS-35N) /41 (TS-35/15N)
Number of poles	01P
Number of positions	01P
Level	1
Connection points	2

Material information

Insulation material	PC
---------------------	----

Insulation material group	IIIa
Flame retardant rating , compliant with UL94	V2
Insulation resistance	□1000MΩ at DC 500V
Conductor material	COPPER ALLOY
Plating of conductor surface	Tin PLATED

Connection data-IEC

Rated voltage (V)	800
Rated current (A)	17.5
Rated voltage (III/3)(V)	800
Rated impulse voltage (III/3)(KV)	8
Conductor cross section solid. min (mm ²)	0.2
Conductor cross section solid.max (mm ²)	1.5
Conductor cross section stranded. min (mm ²)	0.2
Conductor cross section stranded. max (mm ²)	1.5
Screw thread	M3
Philips screwdriver size	PH2
Rated torque (N.m)	0.6~1
Recommend tightening torque. min (N.m)	0.6
Stripping Length (mm)	The stripping length depends on the specification provided by the cablelug manufacturer.
Mounting rail	TS-35N · TS-35/15N
End cover plate required	YES
Grounding connections	NO

Connection data-UL

Rated voltage (UL/CUL Group B)(V)	600
Rated current (UL/CUL Group B)(A)	15
Rated voltage (UL/CUL Group C)(V)	600
Rated current (UL/CUL Group C)(A)	15
Rated voltage (UL/CUL Group D)(V)	600
Rated current (UL/CUL Group D)(A)	15
Min. solid wire connection (AWG) acc. to UL/CUL	26
Max. solid wire connection AWG acc. to UL/CUL	14
Min. stranded wire connection AWG acc. to UL/CUL	26

Max. stranded wire connection AWG acc. to UL/CUL	14
--	----

Environment & Safety

Back of the hand protection (YES or NO)	YES
Finger protection (YES or NO)	YES
Operating temperature. max (°C)	125
Operating temperature. min (°C)	-40

UL Recognized

Wire Range (Group B)(AWG)	26-14/(2)26-(2)16
Rated voltage (Group B)(V)	600
Rated current (Group B)(A)	15/20
Wire Range (Group C)(AWG)	26-14/(2)26-(2)16
Rated voltage (Group C)(V)	600
Rated current (Group C)(A)	15/20
Wire Range (Group D)(AWG)	26-14/(2)26-(2)16
Rated voltage (Group D)(V)	600
Rated current (Group D)(A)	5

CUL Recognized

Wire Range (Group B)(AWG)	26-14/(2)26-(2)16
Rated voltage (Group B)(V)	600
Rated current (Group B)(A)	15/20
Wire Range (Group C)(AWG)	26-14/(2)26-(2)16
Rated voltage (Group C)(V)	600
Rated current (Group C)(A)	15/20
Wire Range (Group D)(AWG)	26-14/(2)26-(2)16
Rated voltage (Group D)(V)	600
Rated current (Group D)(A)	5

VDE Approval

Wire Range (mm ²)	0.2~1.5
Rated voltage (V)	800
Rated current (A)	17.5

Drawings

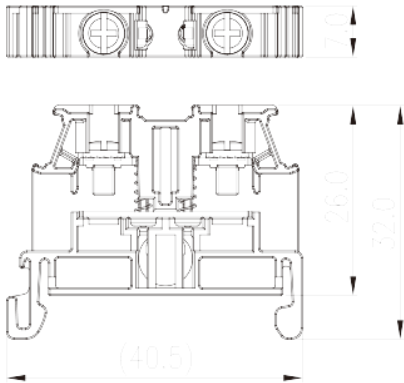

Approvals

