

# DPP2.5N-TP

DIN Rail Terminal Blocks &gt; Push-in Design

Date:2026-04-30

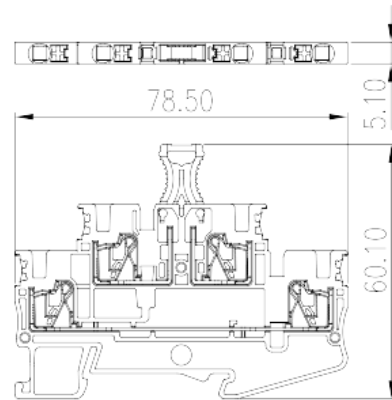
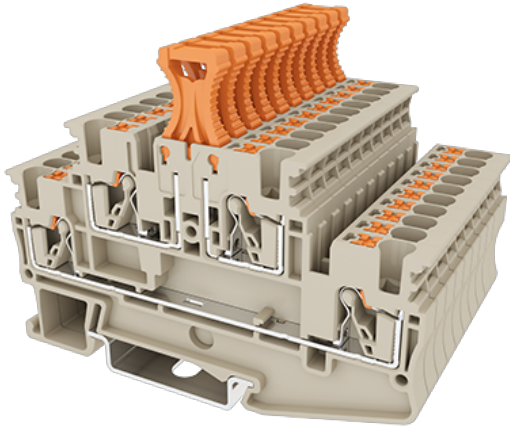

The web catalog is for reference only. Dinkle remains the right of product modification and engineering change of the design. The final product is made according to engineering drawing.

## Product Description

300V, Upper : 18A / Lower : 20A, Beige (default)

## General information

Short description	Bi-level Disconnect Terminal Block, Push-in Design
Category	Bi-level Disconnect Terminal Block
Color	Beige (default)
Connection method	Push-in Design
Type of locking	Rail Mounting
Length (mm)	78.5
Width (mm)	5.1
Height (mm)	60.1
Number of positions	≥2P
Level	Double level
Connection points	4

## Material information

Insulation material	PA
Insulation material group	I
Flame retardant rating , compliant with UL94	V0

Insulation resistance	$\geq 500\text{M}\Omega$ at DC 500V
-----------------------	-------------------------------------

## Connection data-IEC

Rated voltage (V)	400
Rated current (A)	20
Rated voltage (III/3)(V)	400
Rated impulse voltage (III/3)(KV)	6
Conductor cross section solid. min (mm <sup>2</sup> )	0.2
Conductor cross section solid.max (mm <sup>2</sup> )	4
Conductor cross section stranded. min (mm <sup>2</sup> )	0.2
Conductor cross section stranded. max (mm <sup>2</sup> )	2.5
Conductor cross section flexible, with min ferrule without plastic sleeve (mm <sup>2</sup> )	0.25
Conductor cross section flexible, with max ferrule without plastic sleeve (mm <sup>2</sup> )	2.5
Conductor cross section flexible, with min ferrule with plastic sleeve (mm <sup>2</sup> )	0.25
Conductor cross section flexible, with max ferrule with plastic sleeve (mm <sup>2</sup> )	2.5
2 conductors with same cross section flexible, min twin ferrules with plastic sleeve (mm <sup>2</sup> )	0.5
2 conductors with same cross section flexible, max twin ferrules with plastic sleeve (mm <sup>2</sup> )	0.5
Slotted screwdriver size (Blade thickness x Width)(mm)	0.6x3.5
Stripping Length (mm)	10
Mounting rail	TS-35
End cover plate required	YES
Grounding connections	NO

## Connection data-UL

Rated voltage (UL/CUL Group B)(V)	300
Rated current (UL/CUL Group B)(A)	Upper : 18A / Lower : 20A
Rated voltage (UL/CUL Group C)(V)	300
Rated current (UL/CUL Group C)(A)	Upper : 18A / Lower : 20A
Min. solid wire connection (AWG) acc. to UL/CUL	26
Max. solid wire connection AWG acc. to UL/CUL	12
Min. stranded wire connection AWG acc. to UL/CUL	26
Max. stranded wire connection AWG acc. to UL/CUL	12

## Environment & Safety

Back of the hand protection (YES or NO)	YES
Finger protection (YES or NO)	YES
Operating temperature. max (°C)	120
Operating temperature. min (°C)	-40

## UL Recognized

Wire Range (Group B)(AWG)	26~12
Rated voltage (Group B)(V)	300
Rated current (Group B)(A)	18A (Up) / 20A (Bottom)
Wire Range (Group C)(AWG)	26~12
Rated voltage (Group C)(V)	300
Rated current (Group C)(A)	18A (Up) / 20A (Bottom)

## CUL Recognized

Wire Range (Group B)(AWG)	26~12
Rated voltage (Group B)(V)	300
Rated current (Group B)(A)	18A (Up) / 20A (Bottom)
Wire Range (Group C)(AWG)	26~12
Rated voltage (Group C)(V)	300
Rated current (Group C)(A)	18A (Up) / 20A (Bottom)

## Drawings

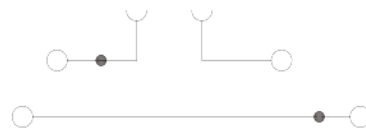
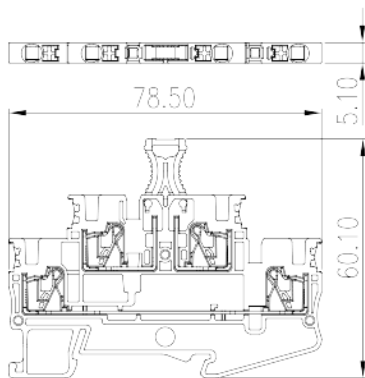

## Approvals

