

DKUUP20-XXPK

NEMA Terminal Blocks > Panel Mounting

Date:2024-07-27

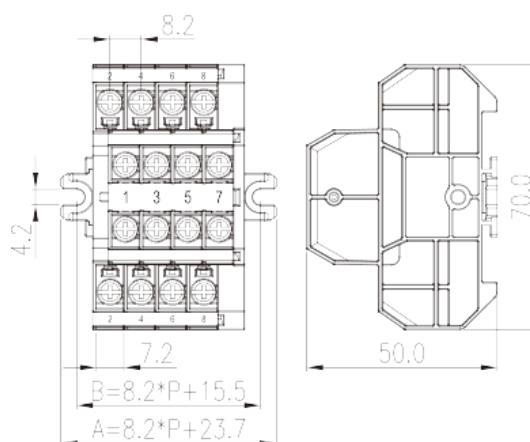
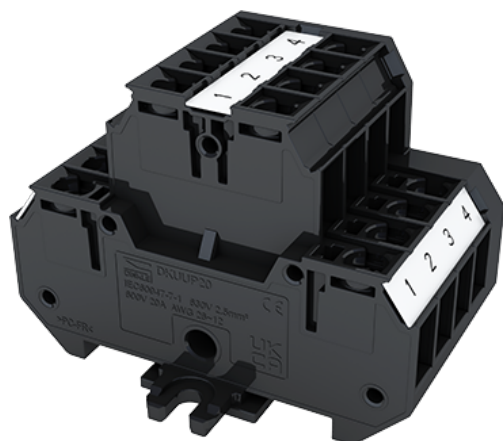

The web catalog is for reference only. Dinkle remains the right of product modification and engineering change of the design. The final product is made according to engineering drawing.

Product Description

M3.5, 600V, 20A

General information

Short description	Panel Mounting Bi-level, Stud Connection
Category	Panel Mounting Bi-level
Pitch (mm)	8.2
Color	Refer to drawing
Connection method	Stud Connection
Length (mm)	$8.2*P+23.7$
Width (mm)	70
Height (mm)	50
Level	Double level
Connection points	4~80

Material information

Insulation material	PC
Insulation material group	Ⅲa
Flame retardant rating , compliant with UL94	V2
Insulation resistance	$\square 1000M\Omega$ at DC 500V

Conductor material	COPPER ALLOY
Plating of conductor surface	Tin PLATED

Connection data-IEC

Rated voltage (V)	630
Rated current (A)	20
Rated voltage (III/3)(V)	630
Rated impulse voltage (III/3)(KV)	8
Screw thread	M3.5
Philips screwdriver size	PH2
Recommend tightening torque. min (N.m)	1
Recommend tightening torque. max (N.m)	1.3
Tightening torque with flange. max (N.m)	0.8
Stripping Length (mm)	The stripping length depends on the specification provided by the cable lug manufacturer
End cover plate required	YES
Grounding connections	NO

Connection data-UL

Rated voltage (UL/CUL Group B)(V)	600
Rated current (UL/CUL Group B)(A)	20
Rated voltage (UL/CUL Group C)(V)	600
Rated current (UL/CUL Group C)(A)	20
Rated voltage (UL/CUL Group D)(V)	600
Rated current (UL/CUL Group D)(A)	20

Environment & Safety

Finger protection (YES or NO)	YES
Operating temperature. max (°C)	125
Operating temperature. min (°C)	-40

UL Recognized

Wire Range (Group B)(AWG)	26-12
Rated voltage (Group B)(V)	600
Rated current (Group B)(A)	20

Wire Range (Group C)(AWG)	26-12
Rated voltage (Group C)(V)	600
Rated current (Group C)(A)	20
Wire Range (Group D)(AWG)	26-12
Rated voltage (Group D)(V)	600
Rated current (Group D)(A)	20

CUL Recognized

Wire Range (Group B)(AWG)	26-12
Rated voltage (Group B)(V)	600
Rated current (Group B)(A)	20
Wire Range (Group C)(AWG)	26-12
Rated voltage (Group C)(V)	600
Rated current (Group C)(A)	20
Wire Ranget (Group D)(AWG)	26-12
Rated voltage (Group D)(V)	600
Rated current (Group D)(A)	20

Drawings

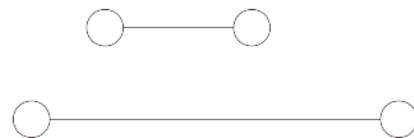
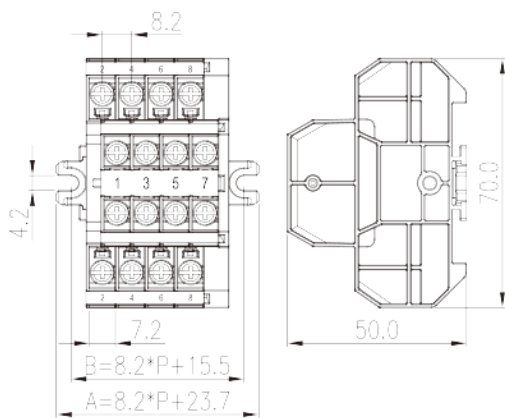

Approvals



