

# DK4-PE

DIN Rail Terminal Blocks > Screw Connection

Date:2026-05-24Version:1.2

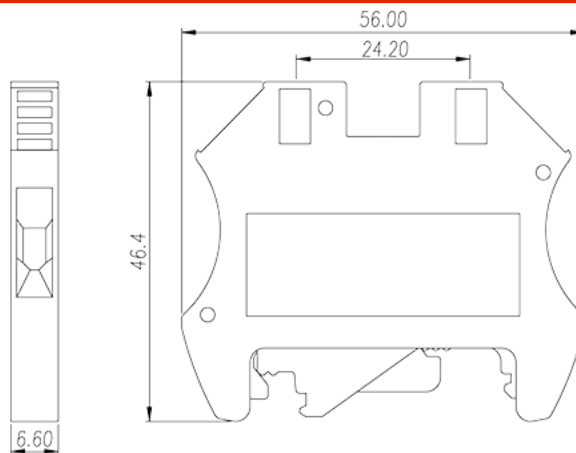
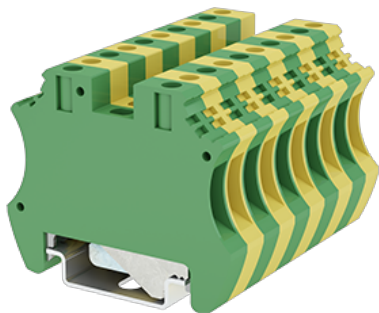

The web catalog is for reference only. Dinkle remains the right of product modification and engineering change of the design. The final product is made according to engineering drawing.

## Product Description

M3, 600V, Green-Yellow (default)

## General information

Short description	DIN rail terminal blocks, Grounding terminal blocks
Category	Grounding terminal blocks
Color	Green-Yellow (default)
Connection method	Screw connection
Type of locking	Rail mounting
Length (mm)	6.6
Width (mm)	56
Height (mm)	46.4
Number of positions	□1P
Level	Single level
Connection points	2

## Material information

Insulation material	PA
Insulation material group	I
Flame retardant rating , compliant with UL94	V0

Insulation resistance

 $\geq 500M\Omega$  at DC 500V

## Connection data-IEC

Rated voltage (V)	630
Rated voltage (III/3)(V)	630
Rated impulse voltage (II/2)(KV)	8
Rated impulse voltage (III/2)(KV)	8
Rated impulse voltage (III/3)(KV)	8
Conductor cross section solid. min (mm <sup>2</sup> )	0.5
Conductor cross section solid.max (mm <sup>2</sup> )	4
Conductor cross section stranded. min (mm <sup>2</sup> )	0.5
Conductor cross section stranded. max (mm <sup>2</sup> )	4
Conductor cross section flexible, with min ferrule without plastic sleeve (mm <sup>2</sup> )	0.5
Conductor cross section flexible, with max ferrule without plastic sleeve (mm <sup>2</sup> )	4
Conductor cross section flexible, with min ferrule with plastic sleeve (mm <sup>2</sup> )	0.5
Conductor cross section flexible, with max ferrule with plastic sleeve (mm <sup>2</sup> )	4
2 conductors with same cross section, solid, max (mm <sup>2</sup> )	2.5
2 conductors with same cross section, stranded, max (mm <sup>2</sup> )	2.5
2 conductors with same cross section flexible, with min ferrule without plastic sleeve (mm <sup>2</sup> )	0.5
2 conductors with same cross section flexible, with max ferrule without plastic sleeve (mm <sup>2</sup> )	2.5
2 conductors with same cross section flexible, min twin ferrules with plastic sleeve (mm <sup>2</sup> )	0.5
2 conductors with same cross section flexible, max twin ferrules with plastic sleeve (mm <sup>2</sup> )	2.5
Screw thread	M3
Slotted screwdriver size (Blade thickness x Width)(mm)	0.8x4.0
Philips screwdriver size	PH1
Rated torque (N.m)	0.78
Stripping Length (mm)	12~16
Mounting rail	TS-35
End cover plate required	NO
Grounding connections	YES

## Connection data-UL

Rated voltage (UL/CUL Group B)(V)	600
Rated voltage (UL/CUL Group C)(V)	600
Rated voltage (UL/CUL Group D)(V)	600
Min. solid wire connection (AWG) acc. to UL/CUL	26
Max. solid wire connection AWG acc. to UL/CUL	10
Min. stranded wire connection AWG acc. to UL/CUL	26
Max. stranded wire connection AWG acc. to UL/CUL	10

## Environment & Safety

Back of the hand protection (YES or NO)	YES
Finger protection (YES or NO)	YES
Operating temperature. max (°C)	120
Operating temperature. min (°C)	-40

## UL Recognized

Wire Range (Group B)(AWG)	26~10
Rated voltage (Group B)(V)	600
Wire Range (Group C)(AWG)	26~10
Rated voltage (Group C)(V)	600
Wire Range (Group D)(AWG)	26~10
Rated voltage (Group D)(V)	600

## CUL Recognized

Wire Range (Group B)(AWG)	26~10
Rated voltage (Group B)(V)	600
Wire Range (Group C)(AWG)	26~10
Rated voltage (Group C)(V)	600
Wire Ranget (Group D)(AWG)	26~10
Rated voltage (Group D)(V)	600

## VDE Approval

Wire Range (mm <sup>2</sup> )	0.5~4
-------------------------------	-------

## Drawings

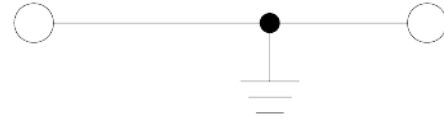
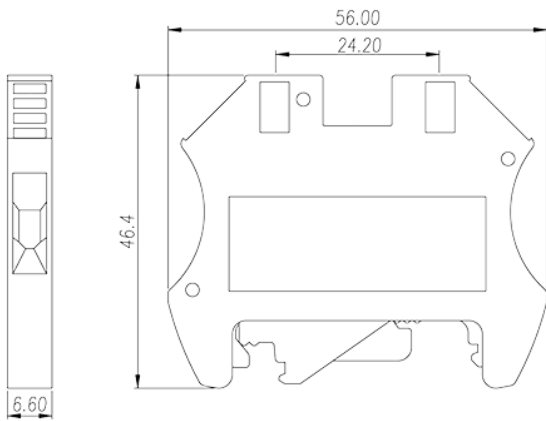

## Approvals

