

DKBH285-XXPCK

NEMA Terminal Blocks > Panel Mounting

Date:2026-06-25

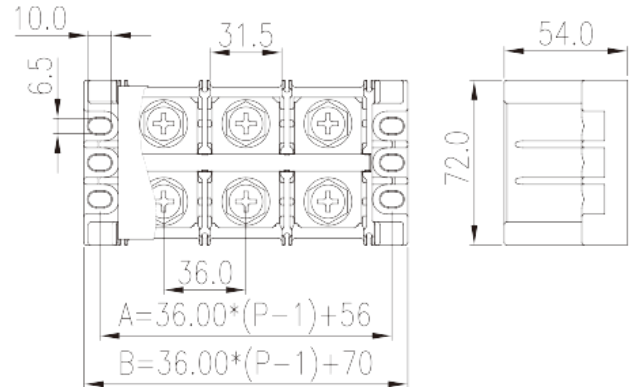
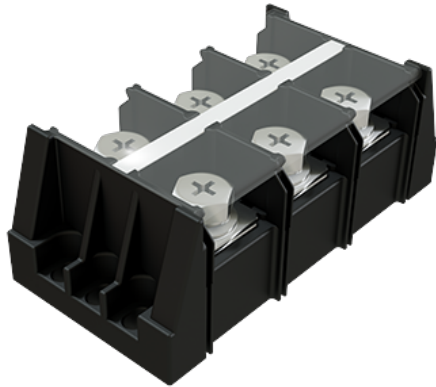

The web catalog is for reference only. Dinkle remains the right of product modification and engineering change of the design. The final product is made according to engineering drawing.

Product Description

1500V, 300A, Beige (default)

General information

Short description	Panel Mounting, Screw Connection
Category	Panel Mounting
Color	Black (default)
Connection method	Screw Connection
Length (mm)	$36.00*(P-1)+70$
Width (mm)	72
Height (mm)	54
Number of positions	02P~08P
Level	Single level
Connection points	4~16

Material information

Insulation material	PBT
Insulation material group	IIIa
Flame retardant rating , compliant with UL94	V0
Insulation resistance	$\square 1000M\Omega$ at DC 500V

Conductor material	COPPER ALLOY
Plating of conductor surface	Ni PLATED

Connection data-IEC

Rated voltage (V)	1500
Rated current (A)	309
Rated voltage (III/3)(V)	1500
Rated impulse voltage (III/3)(KV)	8
Conductor cross section stranded. min (mm ²)	6
Conductor cross section stranded. max (mm ²)	150
Screw thread	M10
Philips screwdriver size	SW17
Recommend tightening torque. min (N.m)	12
Recommend tightening torque. max (N.m)	16
Stripping Length (mm)	The stripping length depends on the specification provided by the cable lug manufacturer
End cover plate required	NO
Grounding connections	NO

Connection data-UL

Rated voltage (UL/CUL Group E)(V)	1500
Rated current (UL/CUL Group E)(A)	285(FW2) & 300(FW1)
Min. stranded wire connection AWG acc. to UL/CUL	8
Max. stranded wire connection AWG acc. to UL/CUL	300(kcmil)

Environment & Safety

Back of the hand protection (YES or NO)	YES
Finger protection (YES or NO)	NO
Operating temperature. max (°C)	125
Operating temperature. min (°C)	-40

UL Recognized

Wire Range (Group E)(AWG)	8~300(kcmil)
Rated voltage (Group E)(V)	1500
Rated current (Group E)(A)	285(FW2),300(FW1)

CUL Recognized

Wire Range (Group C)(AWG)	8~300(kcmil)
Rated voltage (Group C)(V)	1500
Rated current (Group C)(A)	285(FW2)

Drawings

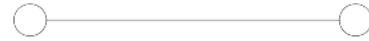
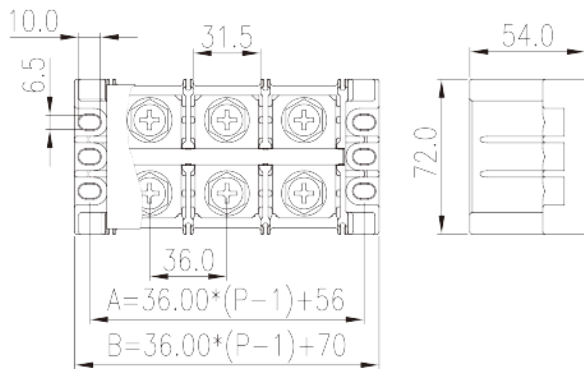

Approvals

