

0256-23XX

PCB Terminal Blocks > PCB Connector-Plug

Date:2026-04-08

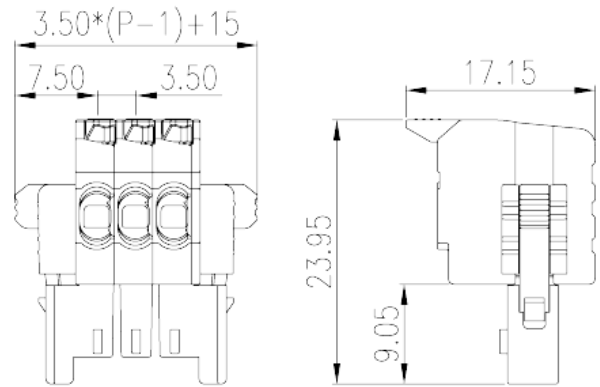

The web catalog is for reference only. Dinkle remains the right of product modification and engineering change of the design. The final product is made according to engineering drawing.

Product Description

Pitch: 3.50mm, 300V, 8A

General information

Short description	PCB Connector, Push-in Design
Category	PCB Connector – Plug
Pitch (mm)	3.50
Connection method	Push-in Design
Type of locking	With lock flange
Length (mm)	$3.50*(P-1)+15$
Width (mm)	17.15
Height (mm)	23.95
Number of positions	02P~24P
Level	Single level

Material information

Insulation material	PA
Insulation material group	I
Flame retardant rating , compliant with UL94	V0
Insulation resistance	$\square 500M\Omega$ at DC 500V

Conductor material	COPPER ALLOY
Plating of conductor surface	Tin PLATED

Connection data-IEC

Rated voltage (V)	320
Rated current (A)	10
Rated voltage (II/2)(V)	320
Rated voltage (III/2) (V)	160
Rated voltage (III/3)(V)	160
Rated impulse voltage (II/2)(KV)	2.5
Rated impulse voltage (III/2)(KV)	2.5
Rated impulse voltage (III/3)(KV)	2.5
Conductor cross section solid. min (mm ²)	0.14
Conductor cross section solid.max (mm ²)	1.5
Conductor cross section stranded. min (mm ²)	0.14
Conductor cross section stranded. max (mm ²)	1.5
Conductor cross section flexible, with min ferrule without plastic sleeve (mm ²)	0.25
Conductor cross section flexible, with max ferrule without plastic sleeve (mm ²)	1.5
Conductor cross section flexible, with min ferrule with plastic sleeve (mm ²)	0.25
Conductor cross section flexible, with max ferrule with plastic sleeve (mm ²)	0.75
2 conductors with same cross section flexible, min twin ferrules with plastic sleeve (mm ²)	0.5
2 conductors with same cross section flexible, max twin ferrules with plastic sleeve (mm ²)	0.5
Stripping Length (mm)	9~10

Connection data-UL

Rated voltage (UL/CUL Group B)(V)	300
Rated current (UL/CUL Group B)(A)	8
Rated voltage (UL/CUL Group C)(V)	150
Rated current (UL/CUL Group C)(A)	8
Rated voltage (UL/CUL Group D)(V)	300
Rated current (UL/CUL Group D)(A)	8
Min. solid wire connection (AWG) acc. to UL/CUL	28

Max. solid wire connection AWG acc. to UL/CUL	16
Min. stranded wire connection AWG acc. to UL/CUL	28
Max. stranded wire connection AWG acc. to UL/CUL	16

Drawings

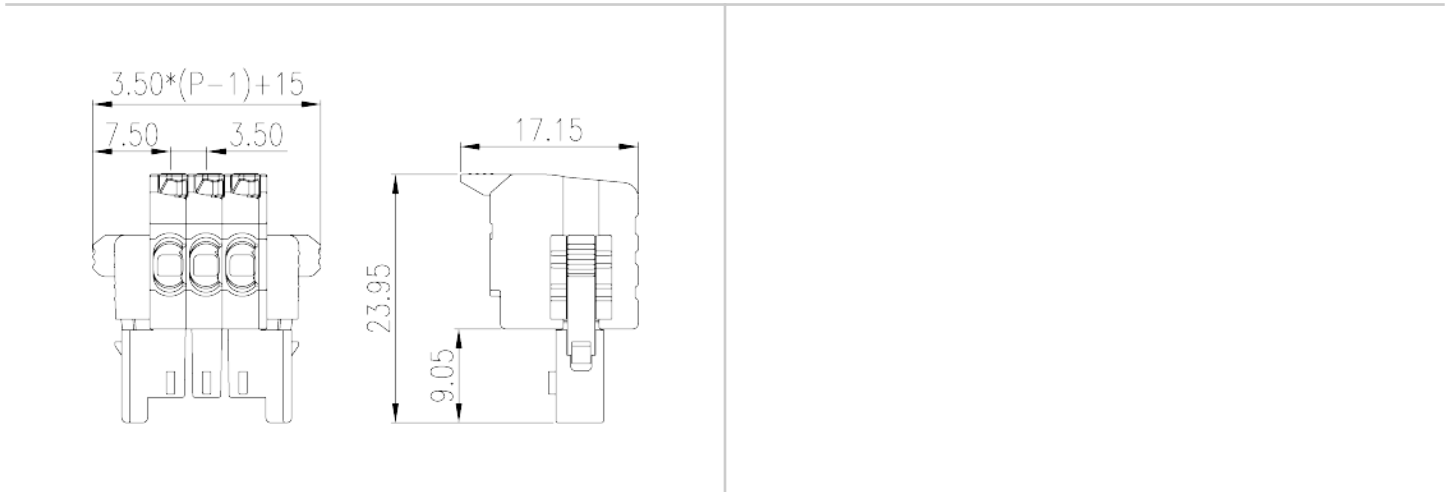

Approvals

