

# DP2.5SGT-L24

DIN Rail Terminal Blocks > Push-in Design

Date:2026-04-30

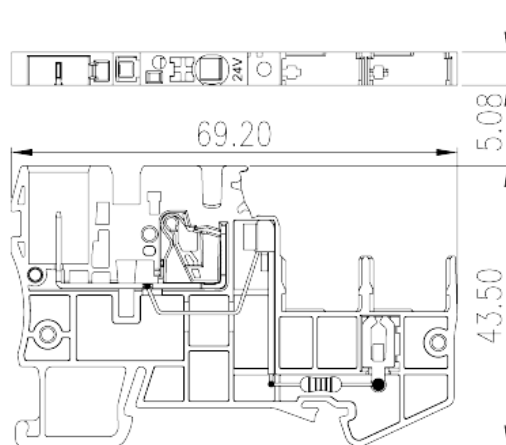
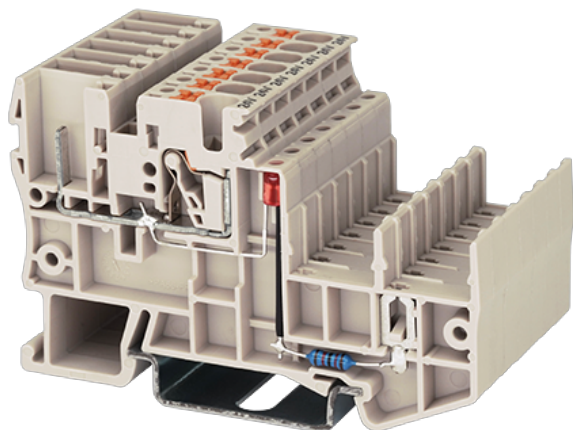

The web catalog is for reference only. Dinkle remains the right of product modification and engineering change of the design. The final product is made according to engineering drawing.

## Product Description

24V, 20A, Beige (default)

## General information

Short description	Component terminal block, Push-in Design
Category	Component terminal block
Color	Refer to drawing
Connection method	Push-in Design
Type of locking	Rail Mounting
Length (mm)	69.2
Width (mm)	5.08
Height (mm)	45 ( TS-35N ) / 52.5 ( TS-35/15N )
Number of positions	≥1P
Level	Single level
Connection points	1

## Material information

Insulation material	PA
Insulation material group	I
Flame retardant rating , compliant with UL94	V0

Insulation resistance

 $\geq 500\text{M}\Omega$  at DC 500V

## Connection data-IEC

Rated voltage (V)	24
Rated current (A)	24
Rated voltage (III/3)(V)	24
Rated impulse voltage (III/3)(KV)	6
Conductor cross section solid. min (mm <sup>2</sup> )	0.2
Conductor cross section solid.max (mm <sup>2</sup> )	4
Conductor cross section stranded. min (mm <sup>2</sup> )	0.2
Conductor cross section stranded. max (mm <sup>2</sup> )	2.5
Conductor cross section flexible, with min ferrule without plastic sleeve (mm <sup>2</sup> )	0.25
Conductor cross section flexible, with max ferrule without plastic sleeve (mm <sup>2</sup> )	2.5
Conductor cross section flexible, with min ferrule with plastic sleeve (mm <sup>2</sup> )	0.25
Conductor cross section flexible, with max ferrule with plastic sleeve (mm <sup>2</sup> )	2.5
2 conductors with same cross section flexible, min twin ferrules with plastic sleeve (mm <sup>2</sup> )	0.5
2 conductors with same cross section flexible, max twin ferrules with plastic sleeve (mm <sup>2</sup> )	0.5
Slotted screwdriver size (Blade thickness x Width)(mm)	0.6x3.5
Stripping Length (mm)	10
Mounting rail	TS-35N · TS-35/15N
End cover plate required	YES
Grounding connections	NO

## Connection data-UL

Rated voltage (UL/CUL Group B)(V)	24
Rated current (UL/CUL Group B)(A)	20
Rated voltage (UL/CUL Group C)(V)	24
Rated current (UL/CUL Group C)(A)	20
Min. solid wire connection (AWG) acc. to UL/CUL	26
Max. solid wire connection AWG acc. to UL/CUL	12
Min. stranded wire connection AWG acc. to UL/CUL	26
Max. stranded wire connection AWG acc. to UL/CUL	12

## Environment & Safety

Back of the hand protection (YES or NO)	YES
Finger protection (YES or NO)	YES
Operating temperature. max (°C)	120
Operating temperature. min (°C)	-40

## Drawings

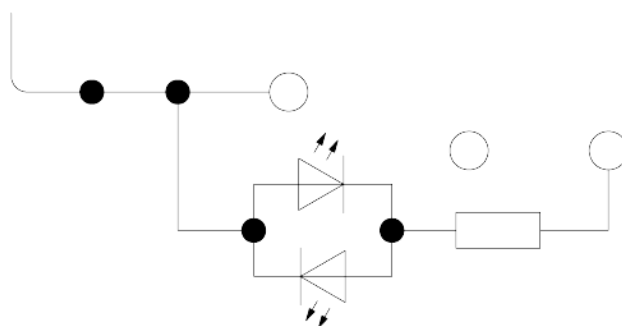
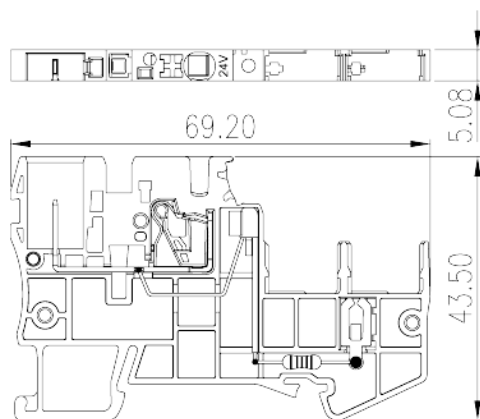

## Approvals

