

# DPH10-PE

DIN Rail Terminal Blocks > Push-in Design

Date:2026-04-30

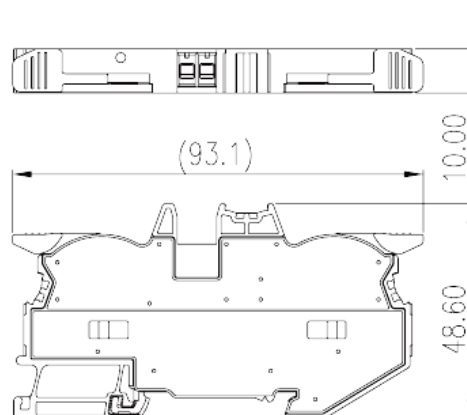
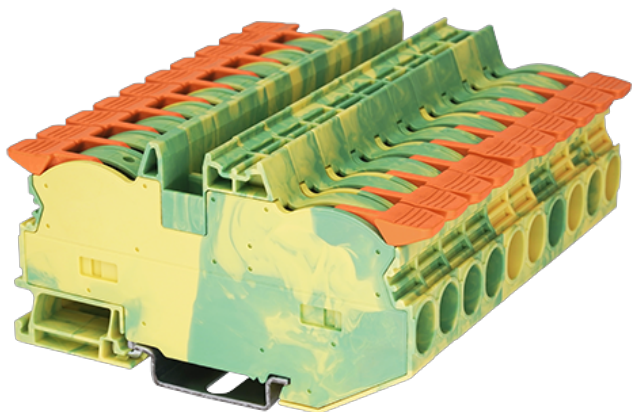

The web catalog is for reference only. Dinkle remains the right of product modification and engineering change of the design. The final product is made according to engineering drawing.

## Product Description

600V, Yellow-Green (default)

## General information

Short description	Grounding Terminal Block, Push-in Design
Category	Grounding Terminal Block
Color	Refer to drawing
Connection method	Push-in Design
Type of locking	Rail Mounting
Length (mm)	93.1
Width (mm)	10
Height (mm)	50.1 ( TS-35N ) / 57.6 ( TS-35/15N )
Number of positions	≥1P
Level	Single level
Connection points	2

## Material information

Insulation material	PA
Insulation material group	I
Flame retardant rating , compliant with UL94	V0

Insulation resistance

□500MΩ at DC 500V

## Connection data-IEC

Rated voltage (V)	1000
Rated voltage (III/3)(V)	1000
Rated impulse voltage (III/3)(KV)	8
Conductor cross section solid. min (mm <sup>2</sup> )	0.5
Conductor cross section solid.max (mm <sup>2</sup> )	16
Conductor cross section stranded. min (mm <sup>2</sup> )	0.5
Conductor cross section stranded. max (mm <sup>2</sup> )	10
Conductor cross section flexible, with min ferrule without plastic sleeve (mm <sup>2</sup> )	0.5
Conductor cross section flexible, with max ferrule without plastic sleeve (mm <sup>2</sup> )	10
Conductor cross section flexible, with min ferrule with plastic sleeve (mm <sup>2</sup> )	0.5
Conductor cross section flexible, with max ferrule with plastic sleeve (mm <sup>2</sup> )	10
2 conductors with same cross section flexible, min twin ferrules with plastic sleeve (mm <sup>2</sup> )	1.5
2 conductors with same cross section flexible, max twin ferrules with plastic sleeve (mm <sup>2</sup> )	4
Slotted screwdriver size (Blade thickness x Width)(mm)	1x5.5
Stripping Length (mm)	18~19
Mounting rail	TS-35N、TS-35/15N
End cover plate required	NO
Grounding connections	YES

## Connection data-UL

Rated voltage (UL/CUL Group B)(V)	600
Rated voltage (UL/CUL Group C)(V)	600
Rated voltage (UL/CUL Group D)(V)	600
Min. solid wire connection (AWG) acc. to UL/CUL	20
Max. solid wire connection AWG acc. to UL/CUL	6
Min. stranded wire connection AWG acc. to UL/CUL	20
Max. stranded wire connection AWG acc. to UL/CUL	6

## Environment & Safety

Back of the hand protection (YES or NO)	YES
Finger protection (YES or NO)	YES
Operating temperature. max (°C)	120
Operating temperature. min (°C)	-40

### UL Recognized

Wire Range (Group B)(AWG)	20~6
Rated voltage (Group B)(V)	600
Wire Range (Group C)(AWG)	20~6
Rated voltage (Group C)(V)	600
Wire Range (Group D)(AWG)	20~6
Rated voltage (Group D)(V)	600

### CUL Recognized

Wire Range (Group B)(AWG)	20~6
Rated voltage (Group B)(V)	600
Wire Range (Group C)(AWG)	20~6
Rated voltage (Group C)(V)	600
Wire Ranget (Group D)(AWG)	20~6
Rated voltage (Group D)(V)	600

### Drawings

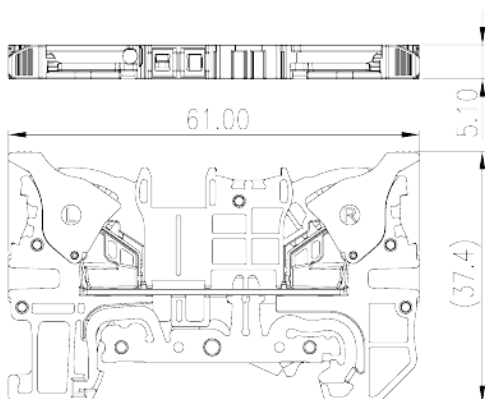

### Approvals

