

0186-10XX

Barrier Terminal Blocks > Single Row

Date:2026-07-01

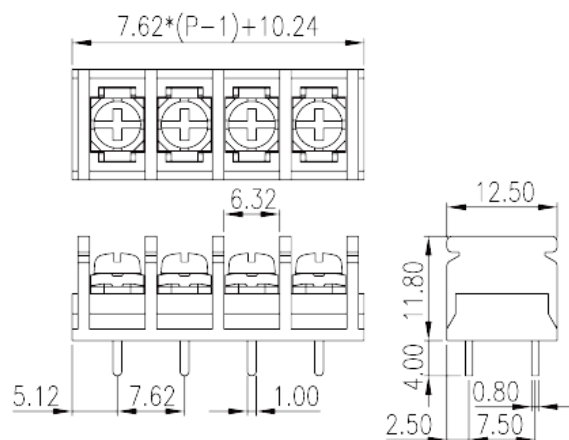
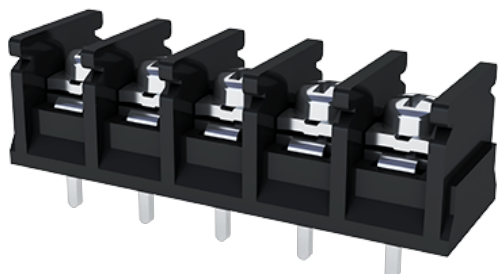

The web catalog is for reference only. Dinkle remains the right of product modification and engineering change of the design. The final product is made according to engineering drawing.

Product Description

Pitch: 7.62mm, M3, 300V, 10A

General information

Short description	Single Row, Screw Connection
Category	Single Row
Pitch (mm)	7.62
Color	Black (default)
Connection method	Screw connection
Type of locking	Without
Soldering method	Wave Soldering
Length (mm)	$7.62*(P-1)+10.24$
Width (mm)	12.5
Height (mm)	11.8
Pin dimensions (Thickness x Width)(mm)	0.8x1
PCB hole diameter (mm)	1.6
Number of positions	02P~11P
Level	Single Row
Connection points	2~11

Material information

Insulation material	PBT
Insulation material group	IIIa
Flame retardant rating , compliant with UL94	V0
Insulation resistance	□1000MΩ at DC 500V
Conductor material	COPPER ALLOY
Plating of conductor surface	Tin PLATED

Connection data-IEC

Rated voltage (V)	320
Rated current (A)	17.5
Rated voltage (II/2)(V)	400
Rated voltage (III/2) (V)	320
Rated voltage (III/3)(V)	250
Rated impulse voltage (II/2)(KV)	4
Rated impulse voltage (III/2)(KV)	4
Rated impulse voltage (III/3)(KV)	4
Conductor cross section solid. min (mm ²)	0.34
Conductor cross section solid.max (mm ²)	1.5
Conductor cross section stranded. min (mm ²)	0.34
Conductor cross section stranded. max (mm ²)	1.5
2 conductors with same cross section, solid, min (mm ²)	0.34
2 conductors with same cross section, solid, max (mm ²)	1.5
2 conductors with same cross section, stranded, min (mm ²)	0.34
2 conductors with same cross section, stranded, max (mm ²)	1.5
Screw thread	M3
Slotted screwdriver size (Blade thickness x Width)(mm)	0.8x4
Philips screwdriver size	PH2
Recommend tightening torque. min (N.m)	0.5
Recommend tightening torque. max (N.m)	0.6
Stripping Length (mm)	9~10

Connection data-UL

--	--

Rated voltage (UL/CUL Group B)(V)	300
Rated voltage (UL/CUL Group D)(V)	300
Rated current (UL/CUL Group D)(A)	10
Min. solid wire connection (AWG) acc. to UL/CUL	22
Max. solid wire connection AWG acc. to UL/CUL	16
Min. stranded wire connection AWG acc. to UL/CUL	22
Max. stranded wire connection AWG acc. to UL/CUL	16

Environment & Safety

Back of the hand protection (YES or NO)	YES
Operating temperature. max (°C)	120
Operating temperature. min (°C)	-40

Drawings

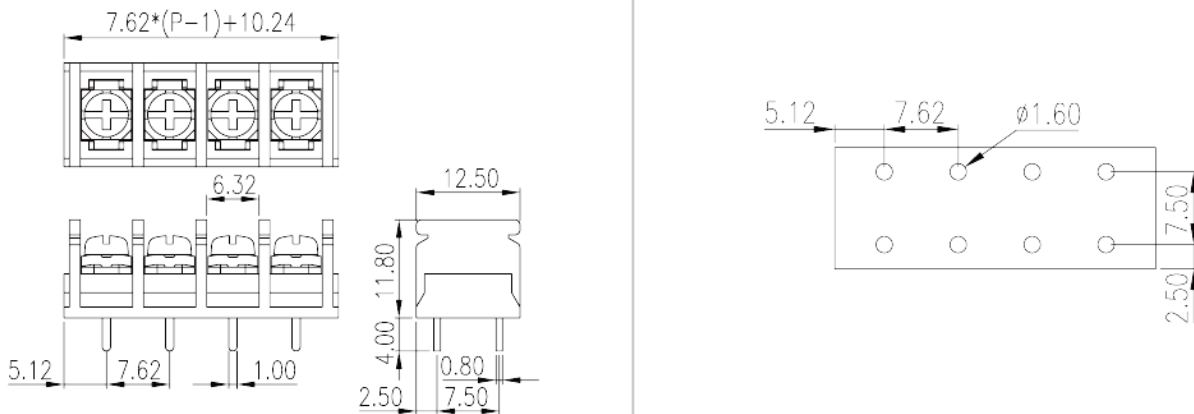

Approvals

