

# DKB80

NEMA Terminal Blocks > Rail Mounting

Date:2026-06-21

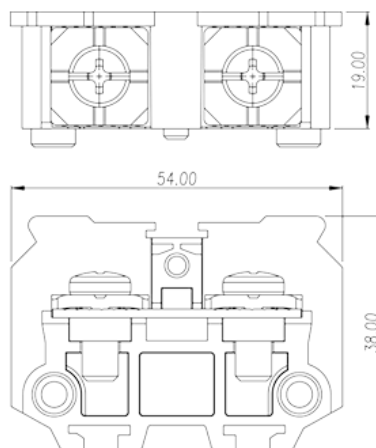
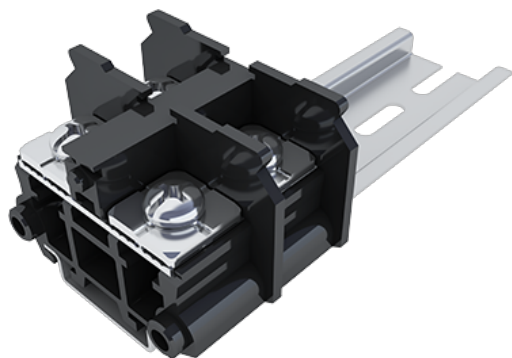

The web catalog is for reference only. Dinkle remains the right of product modification and engineering change of the design. The final product is made according to engineering drawing.

## Product Description

M6, 600V, 85A

## General information

Short description	Feed-Through single level,Screw Connection
Category	Feed-Through single level
Color	Refer to drawing
Connection method	Screw connection
Type of locking	Rail mounting
Length (mm)	54
Width (mm)	19
Height (mm)	41.5(TS-35N) / 49(TS-35/15N)
Level	Single level
Connection points	2

## Material information

Insulation material	PC
Insulation material group	IIIa
Flame retardant rating , compliant with UL94	V2
Insulation resistance	□1000MΩ at DC 500V

Conductor material	COPPER ALLOY
Plating of conductor surface	Ni PLATED

## Connection data-IEC

Rated voltage (V)	800
Rated current (A)	76(0.75~16mm <sup>2</sup> ) / 101(25mm <sup>2</sup> With Ring terminal)
Rated voltage (III/3)(V)	800
Rated impulse voltage (III/3)(KV)	8
Conductor cross section solid. min (mm <sup>2</sup> )	0.75
Conductor cross section solid.max (mm <sup>2</sup> )	16
Conductor cross section stranded. min (mm <sup>2</sup> )	16
Conductor cross section stranded. max (mm <sup>2</sup> )	16 (Bare wire) or 25
Screw thread	M6
Slotted screwdriver size (Blade thickness x Width)(mm)	1.0x5.5
Philips screwdriver size	PH2
Rated torque (N.m)	3
Recommend tightening torque. min (N.m)	2.5
Recommend tightening torque. max (N.m)	3
Stripping Length (mm)	16~17 The stripping length depends on the specification provided by the cable lug manufacturer
Mounting rail	TS-35N · TS-35/15N
End cover plate required	YES
Grounding connections	NO

## Connection data-UL

Rated voltage (UL/CUL Group B)(V)	600
Rated current (UL/CUL Group B)(A)	85
Rated voltage (UL/CUL Group C)(V)	600
Rated current (UL/CUL Group C)(A)	85
Min. solid wire connection (AWG) acc. to UL/CUL	18
Max. solid wire connection AWG acc. to UL/CUL	4
Min. stranded wire connection AWG acc. to UL/CUL	18
Max. stranded wire connection AWG acc. to UL/CUL	4

## Environment & Safety

Back of the hand protection (YES or NO)	YES
Finger protection (YES or NO)	NO
Operating temperature. max (°C)	125
Operating temperature. min (°C)	-40

## UL Recognized

Wire Range (Group B)(AWG)	18~4
Rated voltage (Group B)(V)	600
Rated current (Group B)(A)	85
Wire Range (Group C)(AWG)	18~4
Rated voltage (Group C)(V)	600
Rated current (Group C)(A)	85

## CUL Recognized

Wire Range (Group B)(AWG)	18~4
Rated voltage (Group B)(V)	600
Rated current (Group B)(A)	85
Wire Range (Group C)(AWG)	18~4
Rated voltage (Group C)(V)	600
Rated current (Group C)(A)	85

## VDE Approval

Wire Range (mm <sup>2</sup> )	0.75~25
Rated voltage (V)	800
Rated current (A)	76(0.75~16mm <sup>2</sup> ) / 101(25mm <sup>2</sup> With Ring terminal)

## Drawings

--	--

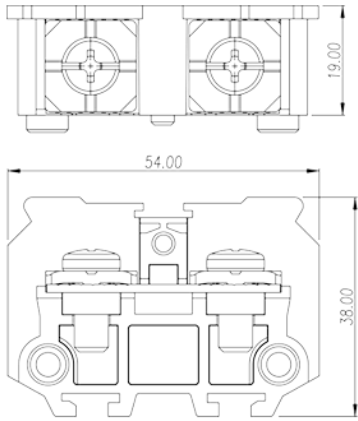

## Approvals

