

P-861

Barrier Terminal Blocks > Wire Terminal

Date:2026-06-13Version:1.2

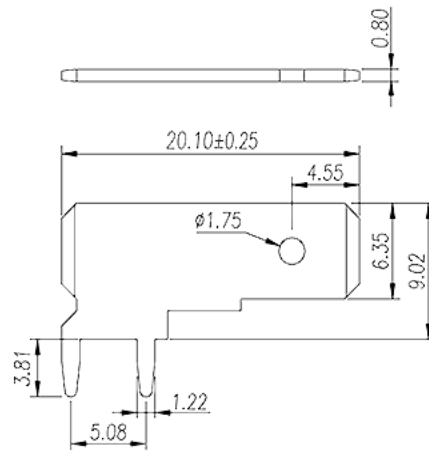
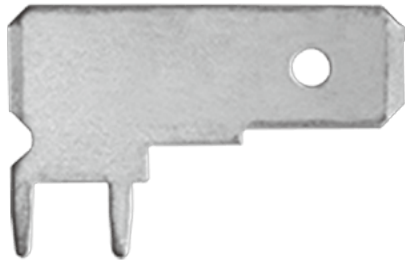

The web catalog is for reference only. Dinkle remains the right of product modification and engineering change of the design. The final product is made according to engineering drawing.

Product Description

Pitch : 5.08mm, 0.8x1.22mm, 30A

General information

| | |
|--|--|
| Short description | Barrier terminal blocks, Quick terminal blocks |
| Category | Quick terminal blocks |
| Pitch (mm) | 5.08 |
| Pin demensions (Thickness x Width)(mm) | 0.8x1.22 |

Material information

| | |
|------------------------------|--------------|
| Conductor material | COPPER ALLOY |
| Plating of conductor surface | Tin PLATED |

Connection data-IEC

| | |
|-------------------|----|
| Rated current (A) | 30 |
|-------------------|----|

Drawings

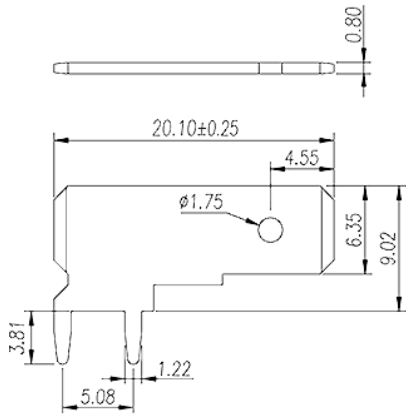

Approvals

