

# P-810

Barrier Terminal Blocks > Wire Terminal

Date:2026-01-28Version:1.2

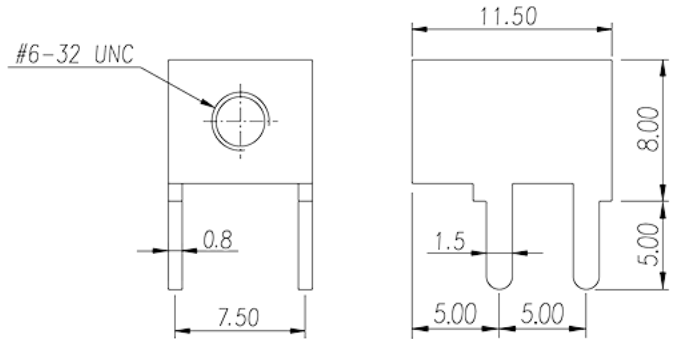
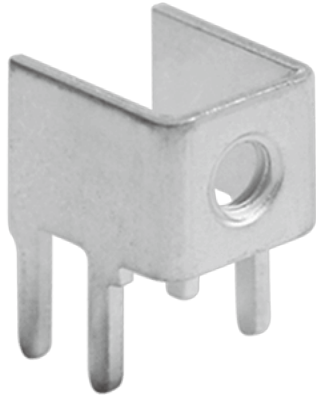

The web catalog is for reference only. Dinkle remains the right of product modification and engineering change of the design. The final product is made according to engineering drawing.

## Product Description

Pin size: 0.8x1.5mm, 80A

## General information

Short description	Barrier terminal blocks, Quick terminal blocks
Category	Quick terminal blocks
Pin demensions (Thickness x Width)(mm)	0.8x1.5

## Material information

Conductor material	COPPER ALLOY
Plating of conductor surface	Tin PLATED

## Connection data-IEC

Rated current (A)	80
Screw thread	#6-32

## Drawings

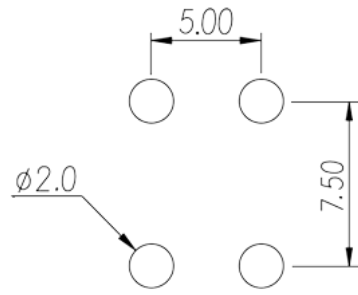
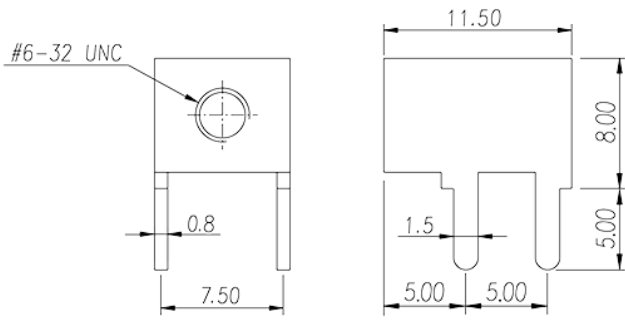

## Approvals

