

# 2EHDRS-XXP

PCB Terminal Blocks &gt; Special Type Terminal Blocks

Date:2026-06-29Version:1.1

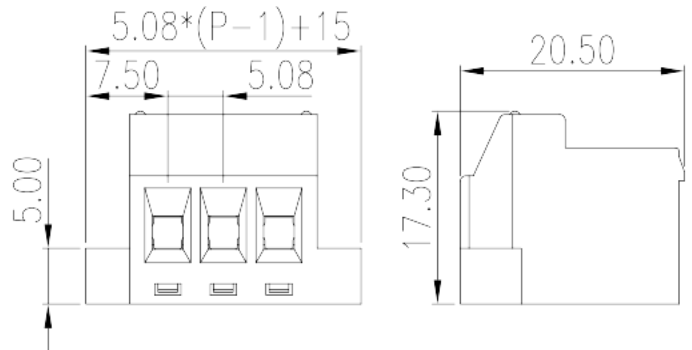
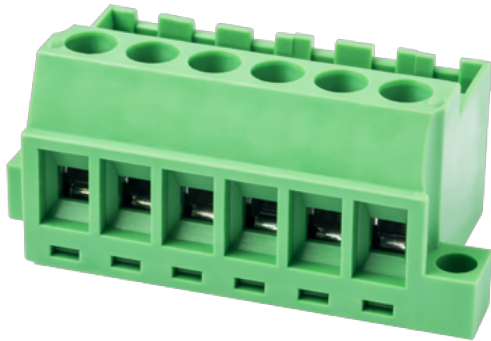

The web catalog is for reference only. Dinkle remains the right of product modification and engineering change of the design. The final product is made according to engineering drawing.

## Product Description

Pitch: 5.08 mm, 300V, 12/15A

## General information

Short description	Special type terminal blocks, Screw connection
Category	Special type terminal blocks
Pitch (mm)	5.08
Color	Green (default)
Connection method	Screw connection
Type of locking	With mounting flange
Length (mm)	$5.08*(P-1)+15$
Width (mm)	20.50
Height (mm)	17.3
Number of positions	02~20P

## Material information

Insulation material	PA
Insulation material group	I
Flame retardant rating , compliant with UL94	V0
Conductor material	COPPER ALLOY

Plating of conductor surface

Tin PLATED

## Connection data-IEC

Rated voltage (V)	630
Rated current (A)	18
Rated voltage (II/2)(V)	600
Rated voltage (III/2) (V)	320
Rated voltage (III/3)(V)	250
Rated impulse voltage (II/2)(KV)	4
Rated impulse voltage (III/2)(KV)	4
Rated impulse voltage (III/3)(KV)	4
Conductor cross section solid. min (mm <sup>2</sup> )	0.5
Conductor cross section solid.max (mm <sup>2</sup> )	2.5
Conductor cross section stranded. min (mm <sup>2</sup> )	0.5
Conductor cross section stranded. max (mm <sup>2</sup> )	2.5
Conductor cross section flexible, with min ferrule without plastic sleeve (mm <sup>2</sup> )	0.25
Conductor cross section flexible, with max ferrule without plastic sleeve (mm <sup>2</sup> )	2.5
Conductor cross section flexible, with min ferrule with plastic sleeve (mm <sup>2</sup> )	0.25
Conductor cross section flexible, with max ferrule with plastic sleeve (mm <sup>2</sup> )	1.5
2 conductors with same cross section, solid, max (mm <sup>2</sup> )	1.5
2 conductors with same cross section, stranded, max (mm <sup>2</sup> )	1.5
2 conductors with same cross section flexible, with min ferrule without plastic sleeve (mm <sup>2</sup> )	0.25
2 conductors with same cross section flexible, with max ferrule without plastic sleeve (mm <sup>2</sup> )	0.75
2 conductors with same cross section flexible, min twin ferrules with plastic sleeve (mm <sup>2</sup> )	0.5
2 conductors with same cross section flexible, max twin ferrules with plastic sleeve (mm <sup>2</sup> )	1.5
Screw thread	M2.5
Slotted screwdriver size (Blade thickness x Width)(mm)	0.6x3.5
Philips screwdriver size	PH1
Rated torque (N.m)	0.75
Stripping Length (mm)	7~8

## Connection data-UL

Rated voltage (UL/CUL Group B)(V)	300
Rated current (UL/CUL Group B)(A)	12/15
Min. solid wire connection (AWG) acc. to UL/CUL	24/28
Max. solid wire connection AWG acc. to UL/CUL	12/16
Min. stranded wire connection AWG acc. to UL/CUL	24/28
Max. stranded wire connection AWG acc. to UL/CUL	12/16

## Environment & Safety

Back of the hand protection (YES or NO)	YES
Finger protection (YES or NO)	YES
Operating temperature. max (°C)	115
Operating temperature. min (°C)	-40

## UL Recognized

Wire Range (Group B)(AWG)	28~12
Rated voltage (Group B)(V)	300
Rated current (Group B)(A)	12/15

## CUL Recognized

Wire Range (Group B)(AWG)	28~12
Rated voltage (Group B)(V)	300
Rated current (Group B)(A)	12/15

## Drawings

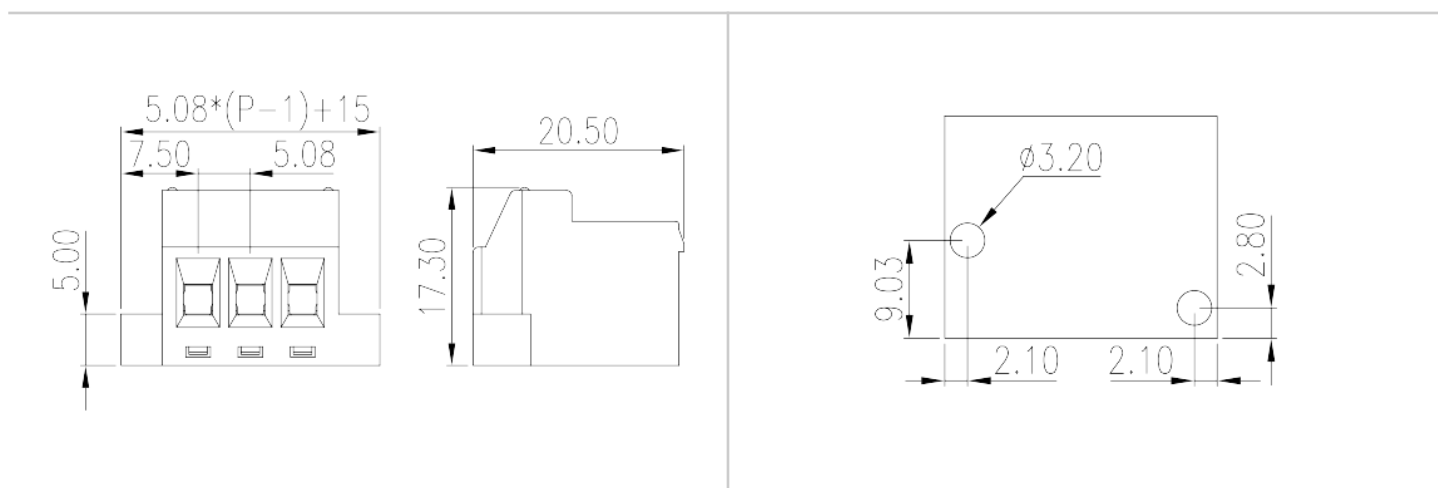

## Approvals

---

