

0226-27XXL

Bornas de Conexión PCB > Bornas Macho PCB

Date:2026-06-16Version:V1

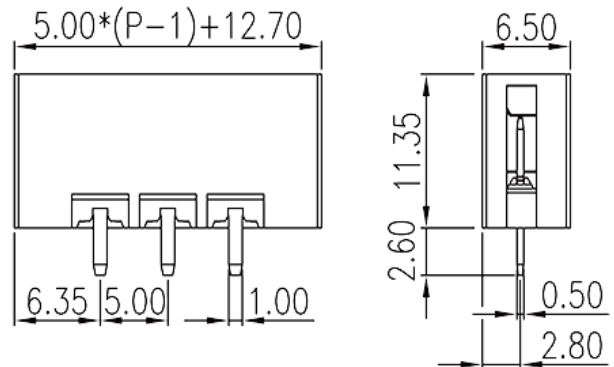

The web catalog is for reference only. Dinkle remains the right of product modification and engineering change of the design. The final product is made according to engineering drawing.

Descripción del producto

Pitch : 5.00 mm, 300V, 10A

Informacion General

Descripción corta	PCB Connector–Socket, Reflow soldering
CategoryCategoría	PCB Connector–Socket
Paso(mm)	5.00
Color	Black (default)
Tipo de anclaje	With mounting flange
Metodo de soldadura	Reflow Soldering (Temperature condition according to standard IPC/JEDEC J-STD-020E)
Largo(mm)	$5.00*(P-1)+12.7$
Ancho(mm)	6.5
Alto (mm)	11.35
Dimensiones del pin (Espesor x anchura)	0.5x1.0
Diametro de taladro en PCB	1.4
Numero de posiciones	02P~16P
Nivel	Single level

Informacion materia prima

Aislante	HIGH-TEMPERATURE PLASTICS
Grupo de aislante	I
Máximo retardo llama, de acuerdo con UL94	V0
Resistencia de aislamiento	□500MΩ at DC 500V
Conductor	COPPER ALLOY
Acabado	Tin PLATED
	2

Datos IEC

Máximo voltaje(V)	630
Máxima corriente (A)	17.5
Máximo voltaje (II/2)(V)	630
Máximo voltaje (III/2)(V)	320
Máximo voltaje (III/3)(V)	320
Máximo voltaje de pico (II/2)(KV)	4
Máximo voltaje de pico (III/2)(KV)	4
Máximo voltaje de pico (III/3)(KV)	4

Datos UL

Máximo voltaje (UL/CUL Group B)(V)	300
Máximo voltaje (UL/CUL Group B)(A)	10
Máximo voltaje (UL/CUL Group D)(V)	300
Máximo voltaje (UL/CUL Group D)(A)	10

Medio ambiente & Seguridad

Protección táctil (si o No)	YES
Máxima temperatura de trabajo (°C)	120
Mínima temperatura de trabajo (°C)	-40

Homologación UL

Máximo voltaje (Group B)(V)	300
Máxima corriente (Group B)(A)	10
Máximo voltaje (Group D)(V)	300
Máxima corriente (Group D)(A)	10

Homologación CUL

Máximo voltaje (Group B)(V)	300
Máxima corriente (Group B)(A)	10
Máximo voltaje (Group D)(V)	300
Máxima corriente (Group D)(A)	10

Dibujo

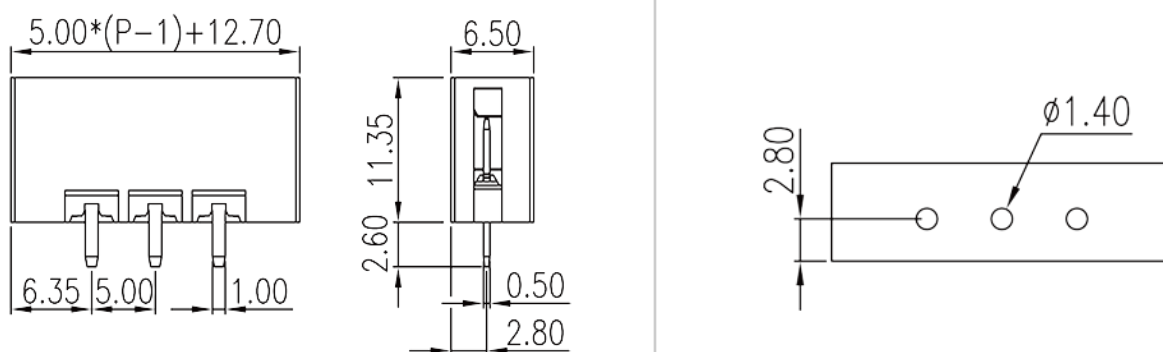

Aprobaciones

