

3EHDV-XXP

Bornas de Conexión PCB > Bornas Macho PCB

Date:2026-06-16Version:V1

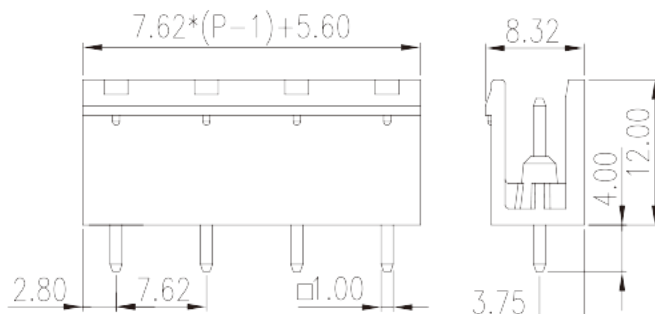

The web catalog is for reference only. Dinkle remains the right of product modification and engineering change of the design. The final product is made according to engineering drawing.

Descripción del producto

Pitch : 7.62 mm, 300V, 25A

Informacion General

Descripción corta	PCB Connector – Socket, Wave soldering
CategoryCategoría	PCB Connector – Socket
Paso(mm)	7.62
Color	Green (default)
Tipo de anclaje	Without
Metodo de soldadura	Wave soldering
Largo(mm)	$7.62*(P-1)+5.6$
Ancho(mm)	8.32
Alto (mm)	12
Dimensiones del pin (Espesor x anchura)	1.0x1.0
Diametro de taladro en PCB	1.6~1.7
Numero de posiciones	02P~14P
Nivel	Single level

Informacion materia prima

Aislante	PA
----------	----

Grupo de aislante	I
Máximo retardo llama, de acuerdo con UL94	V0
Resistencia de aislamiento	□500MΩ at DC 500V
Conductor	COPPER ALLOY
Acabado	Tin PLATED

Datos IEC

Máximo voltaje(V)	800
Máxima corriente (A)	18
Máximo voltaje (II/2)(V)	800
Máximo voltaje (III/2)(V)	630
Máximo voltaje (III/3)(V)	500
Máximo voltaje de pico (II/2)(KV)	6
Máximo voltaje de pico (III/2)(KV)	6
Máximo voltaje de pico (III/3)(KV)	6

Datos UL

Máximo voltaje (UL/CUL Group B)(V)	300
Máximo voltaje (UL/CUL Group B)(A)	25
Máximo voltaje (UL/CUL Group D)(V)	300
Máximo voltaje (UL/CUL Group D)(A)	10

Medio ambiente & Seguridad

Protección táctil (si o No)	YES
Máxima temperatura de trabajo (°C)	120
Mínima temperatura de trabajo (°C)	-40

Homologación UL

Máximo voltaje (Group B)(V)	300
Máxima corriente (Group B)(A)	25
Máximo voltaje (Group D)(V)	300
Máxima corriente (Group D)(A)	10

Homologación CUL

Máximo voltaje (Group B)(V)	300
-----------------------------	-----

Máxima corriente (Group B)(A)	25
Máximo voltaje (Group D)(V)	300
Máxima corriente (Group D)(A)	10

Homologación VDE

Máximo voltaje(V)	800
Máxima corriente (A)	18

Dibujo

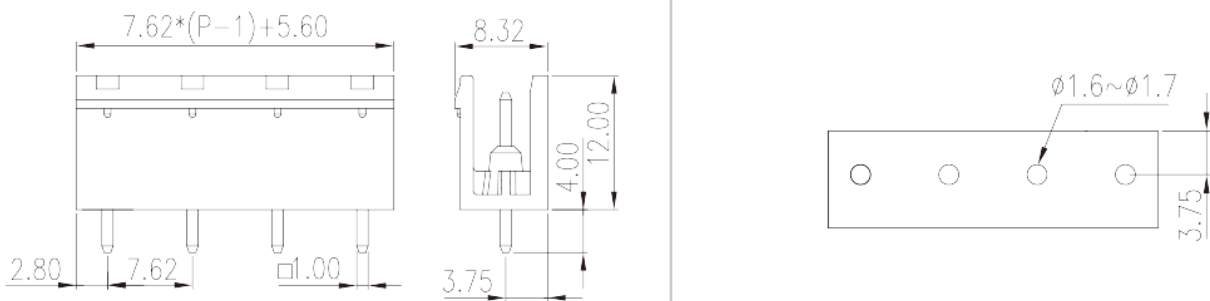

Aprobaciones

