

P-871

Bornas de Conexión de Barrera > Terminal de cable

Date:2026-06-16Version:1.2

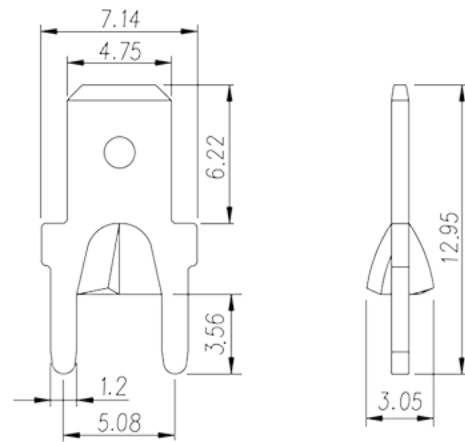

The web catalog is for reference only. Dinkle remains the right of product modification and engineering change of the design. The final product is made according to engineering drawing.

Descripción del producto

Pitch : 5.08mm, 0.8x1.2mm, 30A

Informacion General

Descripción corta	Barrier terminal blocks, Quick terminal blocks
CategoryCategoría	Quick terminal blocks
Paso(mm)	5.08
Dimensiones del pin (Espesor x anchura)	0.8x1.2

Informacion materia prima

Conductor	COPPER ALLOY
Acabado	Tin PLATED

Datos IEC

Máxima corriente (A)	30
----------------------	----

Dibujo

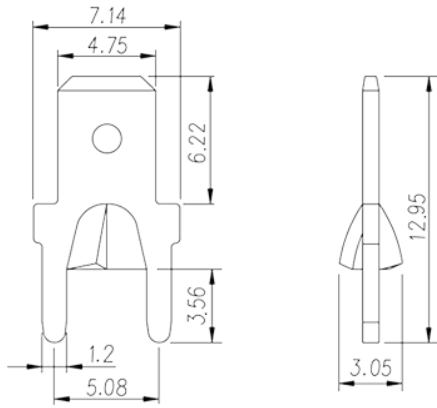

Aprobaciones

