

# 5EHDBR-XXP

Bornas de Conexión PCB &gt; Bornas Macho PCB

Date:2026-06-16Version:V1

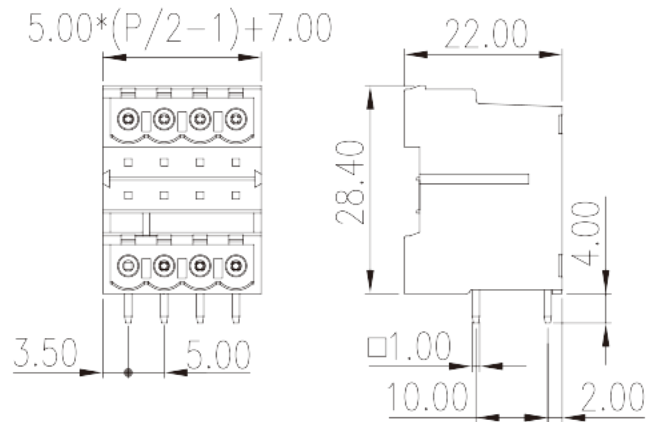

The web catalog is for reference only. Dinkle remains the right of product modification and engineering change of the design. The final product is made according to engineering drawing.

## Descripción del producto

Pitch : 5.00 mm, 300V, 15A

## Informacion General

Descripción corta	PCB Connector – Socket, Wave soldering
CategoryCategoría	PCB Connector – Socket
Paso(mm)	5.00
Color	Green (default)
Tipo de anclaje	Without
Metodo de soldadura	Wave soldering
Largo(mm)	$5.00*(P/2-1)+7.0$
Ancho(mm)	22
Alto (mm)	28.4
Dimensiones del pin (Espesor x anchura)	1.0x1.0
Diametro de taladro en PCB	1.6~1.7
Numero de posiciones	04P~38P
Nivel	Double level

## Informacion materia prima

Aislante	PA
----------	----

Grupo de aislante	I
Máximo retardo llama, de acuerdo con UL94	V0
Resistencia de aislamiento	≥500MΩ at DC 500V
Conductor	COPPER ALLOY
Acabado	Tin PLATED

## Datos IEC

Máximo voltaje(V)	630
Máxima corriente (A)	18
Máximo voltaje (II/2)(V)	630
Máximo voltaje (III/2)(V)	320
Máximo voltaje (III/3)(V)	250
Máximo voltaje de pico (II/2)(KV)	4
Máximo voltaje de pico (III/2)(KV)	4
Máximo voltaje de pico (III/3)(KV)	4

## Datos UL

Máximo voltaje (UL/CUL Group B)(V)	300
Máximo voltaje (UL/CUL Group B)(A)	15
Máximo voltaje (UL/CUL Group D)(V)	300
Máximo voltaje (UL/CUL Group D)(A)	10

## Medio ambiente & Seguridad

Protección táctil (si o No)	YES
Máxima temperatura de trabajo (°C)	120
Mínima temperatura de trabajo (°C)	-40

## Homologación UL

Máximo voltaje (Group B)(V)	300
Máxima corriente (Group B)(A)	15
Máximo voltaje (Group D)(V)	300
Máxima corriente (Group D)(A)	10

## Homologación CUL

Máximo voltaje (Group B)(V)	300
-----------------------------	-----

Máxima corriente (Group B)(A)	15
Máximo voltaje (Group D)(V)	300
Máxima corriente (Group D)(A)	10

### Homologación VDE

Máximo voltaje(V)	600
Máxima corriente (A)	18

### Dibujo

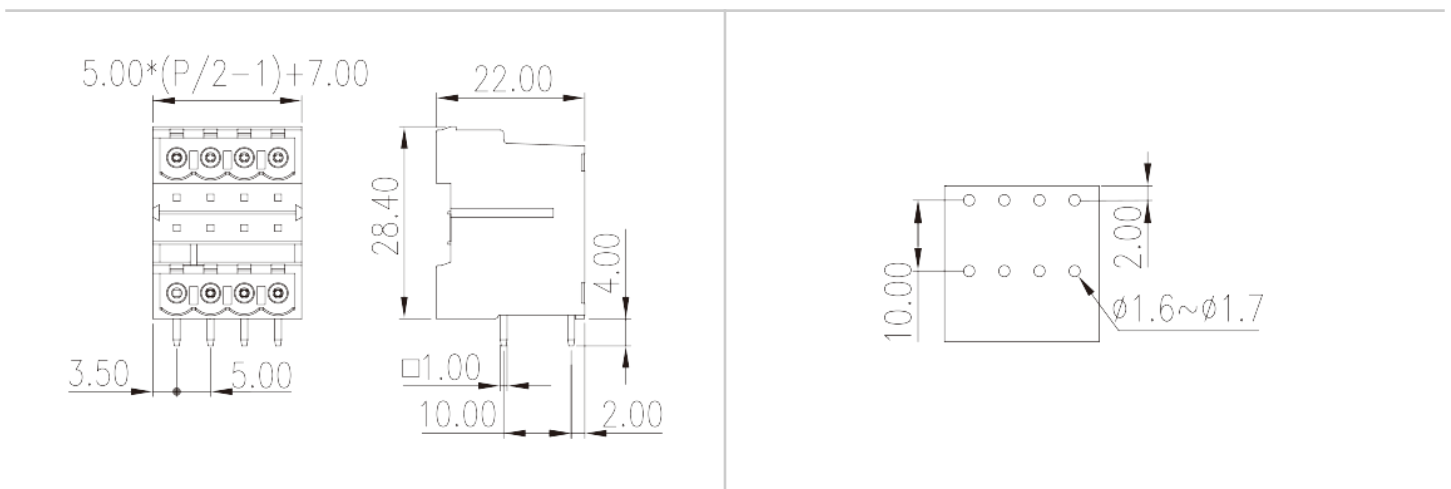

### Aprobaciones

