

# P-872

Morsettiere a barriera > Wire Terminal

Date:2026-05-05Version:1.2

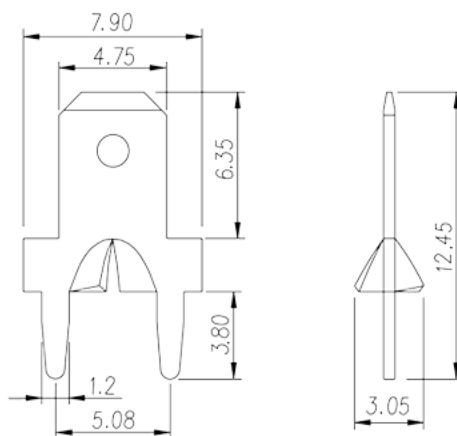
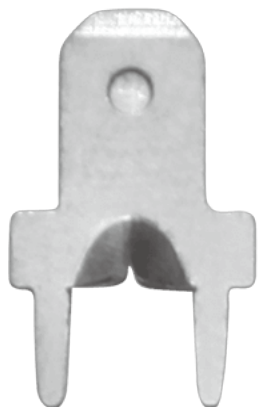

The web catalog is for reference only. Dinkle remains the right of product modification and engineering change of the design. The final product is made according to engineering drawing.

## Descrizione del prodotto

Pitch : 5.08mm, 0.5x1.2mm, 30A

## Informazioni generali

Descrizione breve	Barrier terminal blocks, Quick terminal blocks
Categoria	Quick terminal blocks
Passo(mm)	5.08
Dimensione del pin (mm)	0.5x1.2

## Informazioni sul materiale

Materiale conduttore	COPPER ALLOY
Trattamento della superficie di conduzione	Tin PLATED

## Informazioni sul materiale

Corrente nominale (A)	30
-----------------------	----

## Disegni

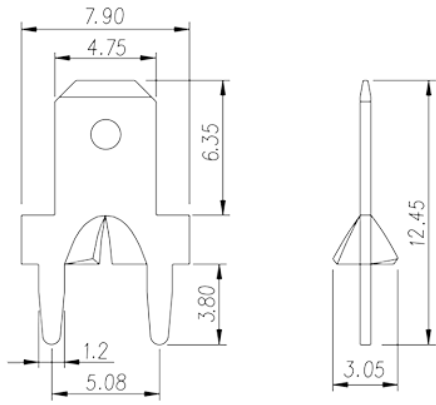

## Approvazioni

