

5ESDV-XXP

PCB > PCB -

:2026-07-04 :1.1

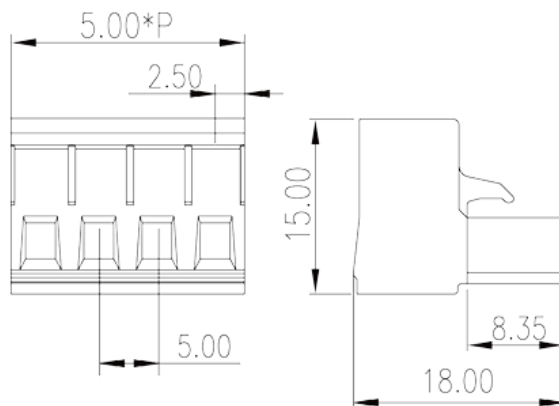

Pitch : 5.00 mm, 300V, 15A

	PCB Connector – Plug, Screw Connection
	PCB Connector – Plug
(mm)	5.00
	Green (default)
	Screw Connection
	Without
(mm)	5.00*P
(mm)	18
(mm)	15
()	02P~24P
	Single level
	PA
	I
UL 94	V0
	500M at DC 500V
	COPPER ALLOY

		Tin PLATED
-IEC		
(V)		600
(A)		18
(II/2)(V)		600
(III/2)(V)		320
(III/3)(V)		250
(II/2)(KV)		4
(III/2)(KV)		4
(III/3)(KV)		4
(mm ²)		0.2
(mm ²)		4
(mm ²)		0.2
(mm ²)		2.5
(mm ²)	,	0.25
(mm ²)	,	2.5
(mm ²)	,	0.25
(mm ²)	,	2.5
2	(mm ²)	0.2
2	(mm ²)	1.5
2	(mm ²)	0.2
2	(mm ²)	1.5
(mm ²) ²	,	0.25
(mm ²) ²	,	0.75
2	(mm ²)	0.5
2	(mm ²)	1.5
		M2.5
Width)(mm)	(Blade thickness x	0.6x3.5
(N.m)		0.5

7~8

-UL

(UL/CUL Group B)(V)	300
(UL/CUL Group B)(A)	15
(UL/CUL Group D)(V)	300
(UL/CUL Group D)(A)	10
UL/CUL AWG	28
UL/CUL AWG	12
UL/CUL AWG	30
UL/CUL AWG	12

&

가 (YES or NO)	YES
	120
	-40

UL

(Group B)(AWG)	30~12
(Group B)(V)	300
(Group B)(A)	15
(Group D)(AWG)	30~12
(Group D)(V)	300
(Group D)(A)	10

CUL

(Group B)(AWG)	30~12
(Group B)(V)	300
(Group B)(A)	15
(Group D)(AWG)	30~12
(Group D)(V)	300
(Group D)(A)	10

VDE

(mm ²)	0.2~4(sol)/0.2~2.5(str)
--------------------	-------------------------

(V)	600
(A)	18

