

EC381VM-XXP

PCB > PCB -

:2026-05-14 :1.1

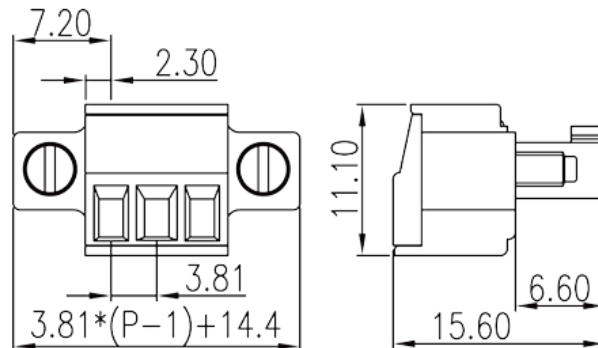
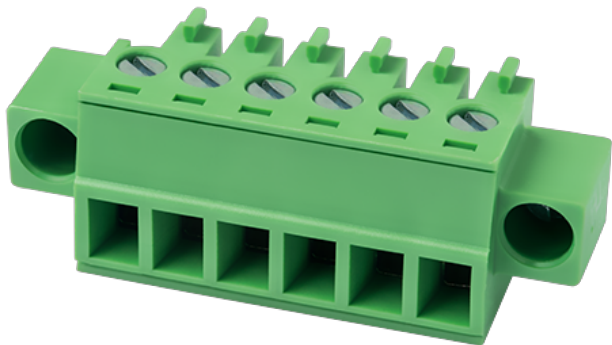

Pitch : 3.81 mm, 300V, 8A

	PCB Connector - Plug, Screw Connection
	PCB Connector - Plug
(mm)	3.81
	Green (default)
	Screw Connection
	With screw flange
(mm)	$3.81 * (P - 1) + 14.4$
(mm)	15.6
(mm)	11.1
()	02P~24P
	Single level
	PA
	I
UL 94	V0
	500M at DC 500V
	COPPER ALLOY

		Tin PLATED
-IEC		
(V)		320
(A)		14
(II/2)(V)		320
(III/2)(V)		160
(III/3)(V)		160
(II/2)(KV)		2.5
(III/2)(KV)		2.5
(III/3)(KV)		2.5
(mm ²)		0.2
(mm ²)		1.5
(mm ²)		0.2
(mm ²)		1.5
(mm ²)	,	0.25
(mm ²)	,	0.75
(mm ²)	,	0.25
(mm ²)	,	0.5
2	(mm ²)	0.2
2	(mm ²)	0.75
2	(mm ²)	0.2
2	(mm ²)	0.75
(mm ²) ²	,	0.5
(mm ²) ²	,	0.5
(mm ²) ²	,	0.5
(mm ²) ²	,	0.5
		M2
Width)(mm)	(Blade thickness x	0.4x2.5
Philips		PH0



(N.m)	0.2
	6~7

-UL

(UL/CUL Group B)(V)	300
(UL/CUL Group B)(A)	8
(UL/CUL Group D)(V)	300
(UL/CUL Group D)(A)	8
UL/CUL AWG	28
UL/CUL AWG	14
UL/CUL AWG	28
UL/CUL AWG	14

&

가 (YES or NO)	YES
	120
	-40

UL

(Group B)(AWG)	28~14
(Group B)(V)	300
(Group B)(A)	8
(Group D)(AWG)	28~14
(Group D)(V)	300
(Group D)(A)	8

CUL

(Group B)(AWG)	28~14
(Group B)(V)	300
(Group B)(A)	8
(Group D)(AWG)	28~14
(Group D)(V)	300
(Group D)(A)	8

VDE

--	--

(mm ²)	0.2~1.5
(V)	320
(A)	14

