

ECH381RJ-XXPL

PCB > PCB -

:2026-07-05

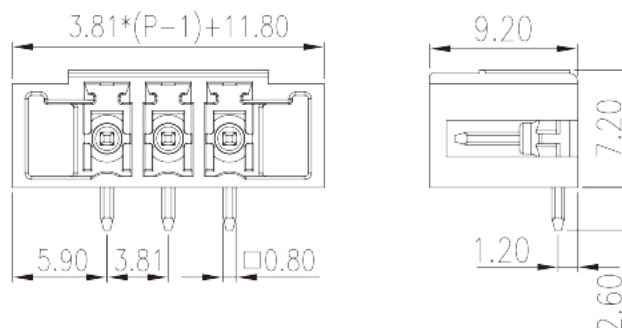

Pitch : 3.81mm, 300V, 8A

	PCB Connector – Socket, Reflow soldering
	PCB Connector – Socket
(mm)	3.81
	Black (default)
	With mounting flange
	Reflow Soldering (Temperature condition according to standard IPC/JEDEC J-STD-020E)
(mm)	$3.81 * (P - 1) + 11.8$
(mm)	9.2
(mm)	7.2
(x) (mm)	0.8x0.8
PCB (mm)	1.4
()	02P~24P
	Single level
	HIGH-TEMPERATURE PLASTICS
	IIIa



UL 94	V0
	500M at DC 500V
	COPPER ALLOY
	Tin PLATED
MSL	1

-IEC

(V)	320
(A)	14
(II/2)(V)	320
(III/2)(V)	160
(III/3)(V)	160
(II/2)(KV)	2.5
(III/2)(KV)	2.5
(III/3)(KV)	2.5

-UL

(UL/CUL Group B)(V)	300
(UL/CUL Group B)(A)	8
(UL/CUL Group D)(V)	300
(UL/CUL Group D)(A)	8

&

가 (YES or NO)	NO
	120
	-40

UL

(Group B)(V)	300
(Group B)(A)	8

CUL

(Group B)(V)	300
(Group B)(A)	8

