

DKK2.5N-D01

DIN

>

:2026-07-05

:1.2

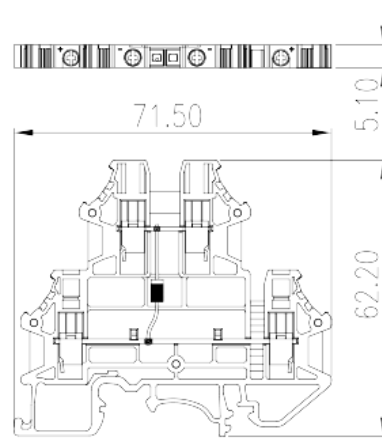
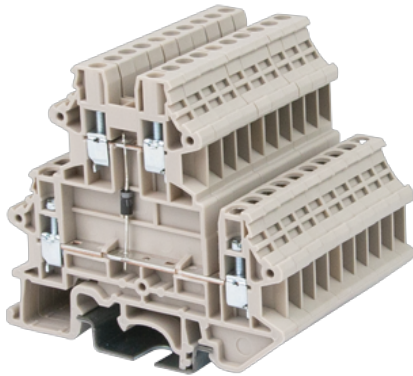

M2.5, 250V, 0.5A, Beige (default)

	DIN rail terminal blocks, Diode terminal blocks
	Diode terminal blocks
	Beige (default)
	Screw connection
	Rail mounting
(mm)	71.5
(mm)	5.1
(mm)	62.2
()	1P
	Double level
	4
	PA
	I
UL 94	V0
	500M at DC 500V

-IEC

(V)		250
(A)		0.5
(III/3)(V)		250
(II/2)(KV)		6
(III/2)(KV)		6
(III/3)(KV)		6
(mm ²)		0.34
(mm ²)		4
(mm ²)		0.34
(mm ²)		2.5
(mm ²)	,	0.34
(mm ²)	,	2.5
(mm ²)	,	0.34
(mm ²)	,	2.5
2	(mm ²)	0.34
2	(mm ²)	2.5
2	(mm ²)	0.34
2	(mm ²)	2.5
(mm ²) 2	,	0.34
(mm ²) 2	,	1.5
2	(mm ²)	0.5
2	(mm ²)	1
		M2.5
Width)(mm)	(Blade thickness x	0.4x2.5
Philips		PH0
(N.m)		0.4
(N.m)		0.4
(N.m)		0.5
		9~11

	TS-35
	YES
	NO

-UL

(UL/CUL Group B)(V)	250
(UL/CUL Group B)(A)	0.5
(UL/CUL Group C)(V)	250
(UL/CUL Group C)(A)	0.5
UL/CUL AWG	22
UL/CUL AWG	12
UL/CUL AWG	22
UL/CUL AWG	12

&

(YES or NO)	YES
가 (YES or NO)	YES
	120
	-40

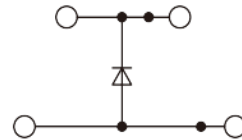
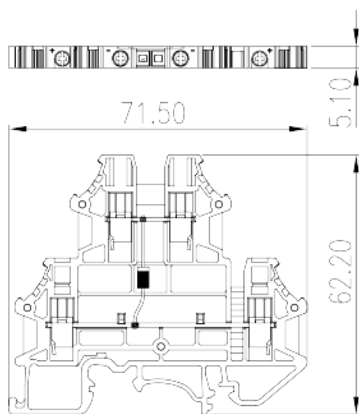



Delight Through Connections

