

DKM185-U

DIN

>

:2026-07-04

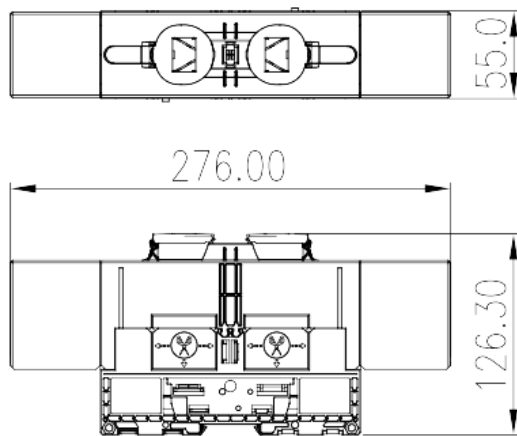

M12, 1500V, 400A, Beige (default)

	Feed-through Single Level, Stud Connection
	Feed-through Single Level
	Refer to drawing
	Stud Connection
(mm)	276
(mm)	55
(mm)	126.3
	Single level
	2
	PA
	I
UL 94	V0
	500M at DC 500V
	-IEC
(V)	1500

(A)	353
(III/3)(V)	1500
(III/3)(KV)	8
(mm ²)	10
(mm ²)	185
(mm ²)	10
(mm ²)	185
	M12
Philips	18X10, 18X12.5
(N.m)	14
(N.m)	31
	The stripping length depends on the specification provided by the cable lug manufacturer
	TS-35
	NO
	NO

-UL

(UL/CUL Group E)(V)	1500
(UL/CUL Group E)(A)	*Single-Cable 310A / Double-Cable 400A
UL/CUL AWG	8
UL/CUL AWG	350 (kcmil)
UL/CUL AWG	8
UL/CUL AWG	350 (kcmil)

&

(YES or NO)	YES
가 (YES or NO)	NO
	120
	-40

UL

(Group E)(AWG)	8~350 (kcmil)
(Group E)(V)	1500
(Group E)(A)	*Single-Cable 310A / Double-Cable 400A

CUL

(Group E)(AWG)	8~350 (kcmil)
(Group E)(V)	1500
(Group E)(A)	*Single-Cable 310A / Double-Cable 400A

