

0256-34XX

PCB > PCB -

:2026-07-06

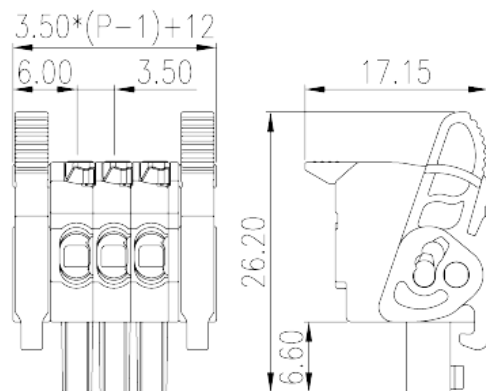

Pitch: 3.50mm, 300V, 8A

	PCB Connector, Push-in Design
	PCB Connector – Plug
(mm)	3.50
	Push-in Design
	With release tool
(mm)	$3.50 * (P-1) + 12$
(mm)	17.15
(mm)	21.5
()	02P~24P
	Single level
	PA
	I
UL 94	V0
	500M at DC 500V
	COPPER ALLOY
	Tin PLATED

-IEC

(V)	320
(A)	10
(II/2)(V)	320
(III/2)(V)	160
(III/3)(V)	160
(II/2)(KV)	2.5
(III/2)(KV)	2.5
(III/3)(KV)	2.5
(mm ²)	0.14
(mm ²)	1.5
(mm ²)	0.14
(mm ²)	1.5
(mm ²) , ,	0.25
(mm ²) , ,	1.5
(mm ²) , ,	0.25
(mm ²) , ,	0.75
2 (mm ²) , ,	0.5
2 (mm ²) , ,	0.5
	9~10

-UL

(UL/CUL Group B)(V)	300
(UL/CUL Group B)(A)	8
(UL/CUL Group C)(V)	150
(UL/CUL Group C)(A)	8
(UL/CUL Group D)(V)	300
(UL/CUL Group D)(A)	8
UL/CUL AWG	28
UL/CUL AWG	16
UL/CUL AWG	28

UL/CUL	AWG	16
&		
가	(YES or NO)	YES
		120
		-40

