

0168-35XX

>

:2026-07-04 :1.1

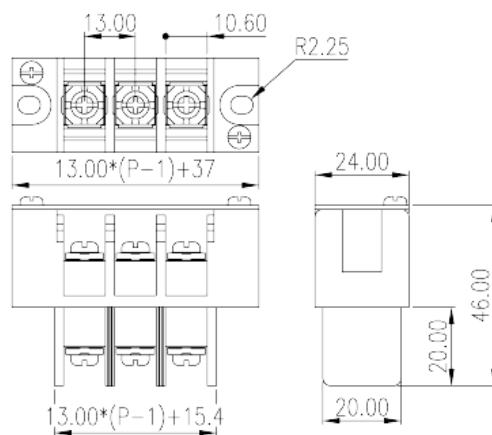
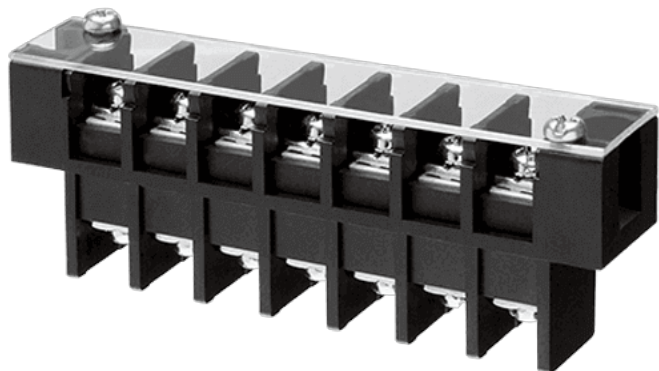

Pitch: 13mm , M4, 600V, 50A

	Barrier terminal blocks , Screw connection
	Panel Feed Through Terminal Blocks
(mm)	13
	Black(default)
	Screw connection
	With mounting flange
	Single level
	PBT
	IIIa
UL 94	V0
	Copper Alloy
	Tinned
-IEC	
(V)	630
(A)	57



(II/2)(V)		1000
(III/2)(V)		1000
(III/3)(V)		630
(II/2)(KV)		8
(III/2)(KV)		8
(III/3)(KV)		8
(mm ²)		0.34
(mm ²)		10
(mm ²)		0.34
(mm ²)		10
2	(mm ²)	6
2	(mm ²)	6
		M4
Width)(mm)	(Blade thickness x	1.0x5.5
Philips		PH2
(N.m)		1.8
(N.m)		1.2
(N.m)		1.8
		8

-UL

(UL/CUL Group B)(V)		600
(UL/CUL Group B)(A)		50
(UL/CUL Group C)(V)		600
(UL/CUL Group C)(A)		50
UL/CUL	AWG	22
UL/CUL	AWG	8
UL/CUL	AWG	22
UL/CUL	AWG	8

&

(YES or NO)		YES
		120
		-40

UL

(Group B) (AWG)	22~8
(Group B) (V)	600
(Group B) (A)	50
(Group C) (AWG)	22~8
(Group C) (V)	600
(Group C) (A)	50

CUL

(Group B) (AWG)	22~8
(Group B) (V)	600
(Group B) (A)	50
(Group C) (AWG)	22~8
(Group C) (V)	600
(Group C) (A)	50

VDE

(mm ²)	0.34~10
(V)	630
(A)	57

