

P-871

>

:2026-07-04

:1.2

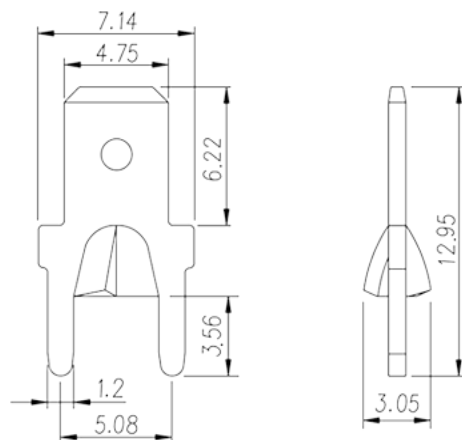

Pitch : 5.08mm, 0.8x1.2mm, 30A

	Barrier terminal blocks, Quick terminal blocks
	Quick terminal blocks
(mm)	5.08
(x) (mm)	0.8x1.2
	COPPER ALLOY
	Tin PLATED
-IEC	
(A)	30

