

ECH350R-XXP

PCB > PCB -

:2026-07-04 :V1

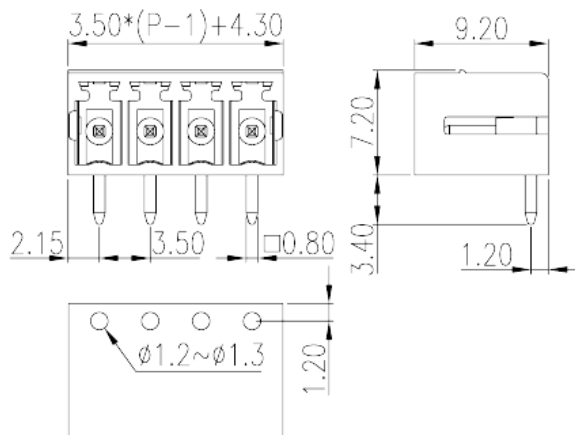

Pitch : 3.50 mm, 300V, 8A

	PCB Connector – Socket, Wave soldering
	PCB Connector – Socket
(mm)	3.50
	Green (default)
	Without
	Wave soldering
(mm)	$3.50 \times (P-1) + 4.3$
(mm)	9.2
(mm)	7.2
(x) (mm)	0.8x0.8
PCB (mm)	1.2~1.3
()	02P~24P
	Single level
	PA
	I
UL 94	V0



	500M at DC 500V
	COPPER ALLOY
	Tin PLATED

-IEC

(V)	320
(A)	14
(II/2)(V)	320
(III/2)(V)	160
(III/3)(V)	160
(II/2)(KV)	2.5
(III/2)(KV)	2.5
(III/3)(KV)	2.5

-UL

(UL/CUL Group B)(V)	300
(UL/CUL Group B)(A)	8
(UL/CUL Group D)(V)	300
(UL/CUL Group D)(A)	8

&

가 (YES or NO)	YES
	120
	-40

UL

(Group B)(V)	300
(Group B)(A)	8
(Group D)(V)	300
(Group D)(A)	8

CUL

(Group B)(V)	300
(Group B)(A)	8
(Group D)(V)	300

(Group D)(A)

8

VDE

(V)

320

(A)

14

