

5EHDR-XXP

PCB > PCB -

:2026-07-04 :V1

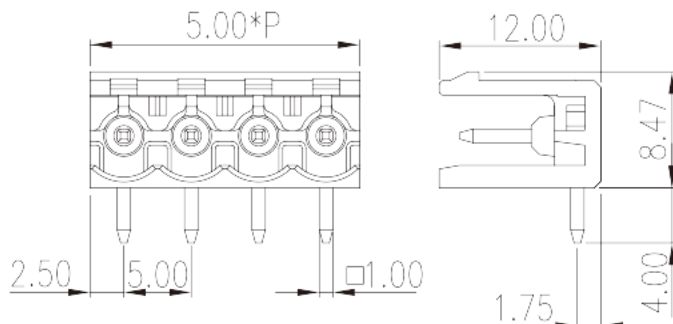
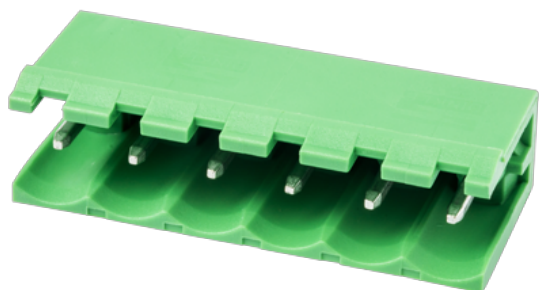

Pitch : 5.00 mm, 300V, 15A

	PCB Connector – Socket, Wave soldering
	PCB Connector – Socket
(mm)	5.00
	Green (default)
	Without
	Wave soldering
(mm)	5.00*P
(mm)	12
(mm)	8.47
(x) (mm)	1.0x1.0
PCB (mm)	1.6~1.7
()	02P~24P
	Single level
	PA
	I
UL 94	V0



	500M at DC 500V
	COPPER ALLOY
	Tin PLATED

-IEC

(V)	600
(A)	18
(II/2)(V)	600
(III/2)(V)	320
(III/3)(V)	250
(II/2)(KV)	4
(III/2)(KV)	4
(III/3)(KV)	4

-UL

(UL/CUL Group B)(V)	300
(UL/CUL Group B)(A)	15
(UL/CUL Group D)(V)	300
(UL/CUL Group D)(A)	10

&

가 (YES or NO)	YES
	120
	-40

UL

(Group B)(V)	300
(Group B)(A)	15
(Group D)(V)	300
(Group D)(A)	10

CUL

(Group B)(V)	300
(Group B)(A)	15
(Group D)(V)	300

(Group D)(A)

10

VDE

(V)

600

(A)

18

