

0156-20XXL

PCB > PCB -

:2026-07-05 :V1

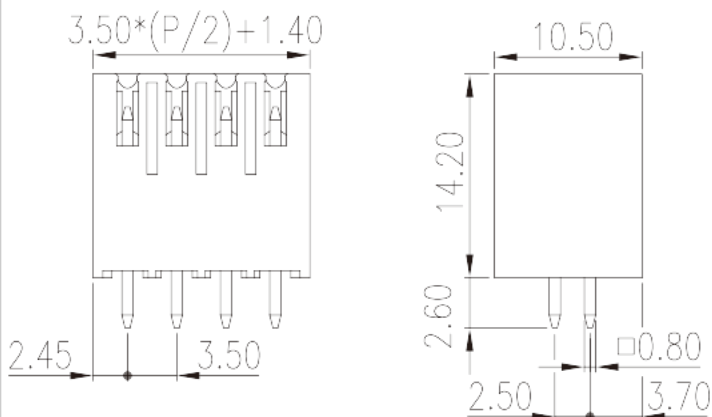

Pitch : 3.50 mm, 150V, 10A

	PCB Connector – Socket, Reflow soldering
	PCB Connector – Socket
(mm)	3.5
	Black (default)
	Without
	Reflow Soldering (Temperature condition according to standard IPC/JEDEC J-STD-020E)
(mm)	$3.50 * (P/2) + 1.4$
(mm)	10.5
(mm)	14.2
(x) (mm)	0.8x0.8
PCB (mm)	1.4
()	04P~44P
	Double level
	HIGH-TEMPERATURE PLASTICS
	IIIa



UL 94	V0
	500M at DC 500V
	COPPER ALLOY
	Tin PLATED
MSL	I

-IEC

(V)	320
(A)	10
(II/2)(V)	320
(III/2)(V)	160
(III/3)(V)	160
(II/2)(KV)	2.5
(III/2)(KV)	2.5
(III/3)(KV)	2.5

-UL

(UL/CUL Group B)(V)	150
(UL/CUL Group B)(A)	10

&

가 (YES or NO)	YES
	120
	-40

UL

(Group B)(V)	150
(Group B)(A)	10

CUL

(Group B)(V)	150
(Group B)(A)	8

VDE

(V)	320
-----	-----

(A)

10

