

P-810N

栅板式端子 > 独立端子

下载日期:2026-05-17版次:1.2

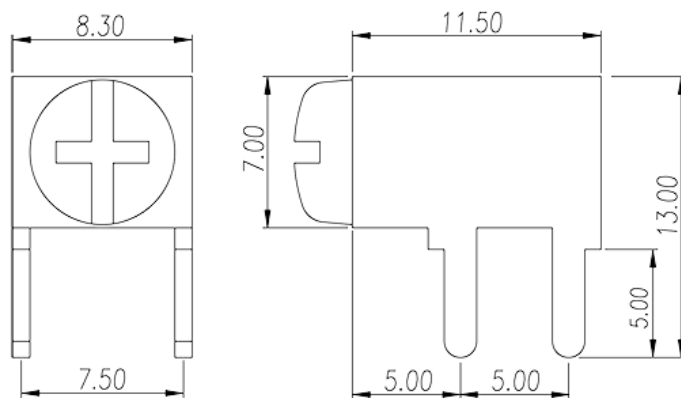
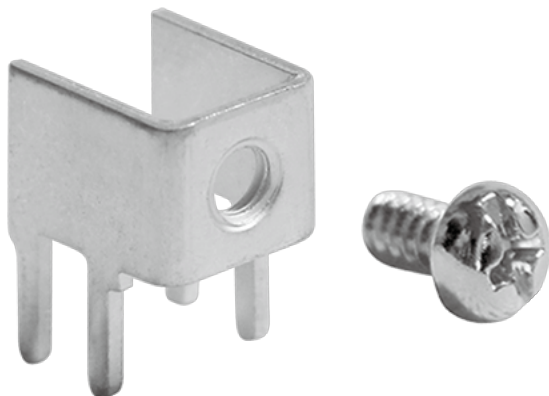

目录仅供参考，实际规格仍依照产品工程图面为准

产品介绍

Pin size:0.8x1.5mm, 80A

一般资讯

产品概述	Barrier terminal blocks, Quick terminal blocks
产品类型	Quick terminal blocks
引脚尺寸 (厚度__ x 宽度__mm)	0.8x1.5

材料信息

导体材料	COPPER ALLOY
导体表面镀层	Tin PLATED

连接数据-IEC

额定电流 (A)	80
螺纹规格	#6-32
一字螺丝刀规格 (刃厚_x刃宽_)(mm)	0.8x4.0
螺丝刀规格	PH2
建议最小扭矩 (N.m)	0.8
建议最大扭矩 (N.m)	1

图面

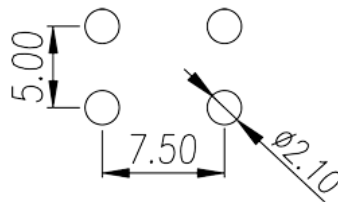
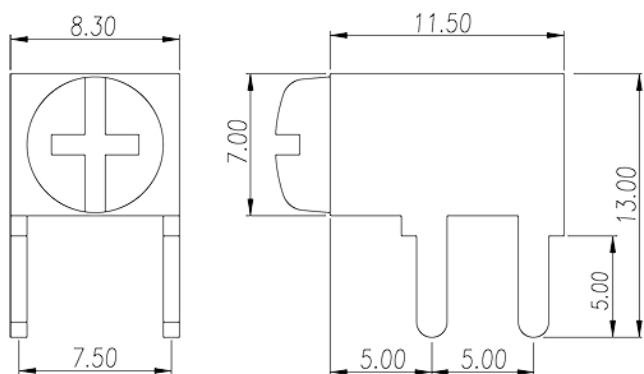

认证

