

P-840

栅板式端子 > 独立端子

下载日期:2026-05-17版次:1.2

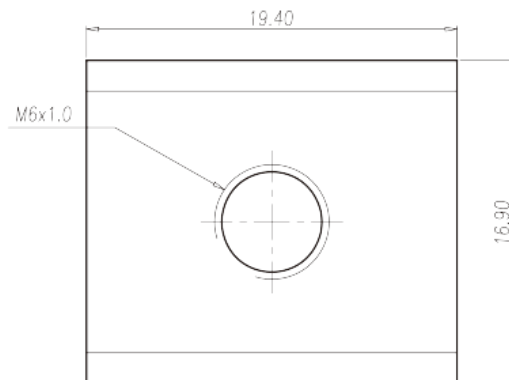

目录仅供参考，实际规格仍依照产品工程图面为准

产品介绍

Pitch : 15.30 / 15.40mm, 1.6x4.0mm, 150A

一般资讯

产品概述	Barrier terminal blocks, Quick terminal blocks
产品类型	Quick terminal blocks
产品间距 (mm)	15.30 / 15.40
引脚尺寸 (厚度___ x 宽度___mm)	1.6x4.0

材料信息

导体材料	COPPER ALLOY
导体表面镀层	Tin PLATED

连接数据-IEC

额定电流 (A)	150
螺纹规格	M6

图面

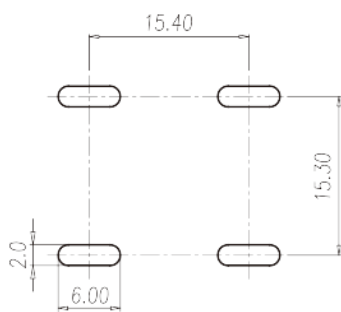
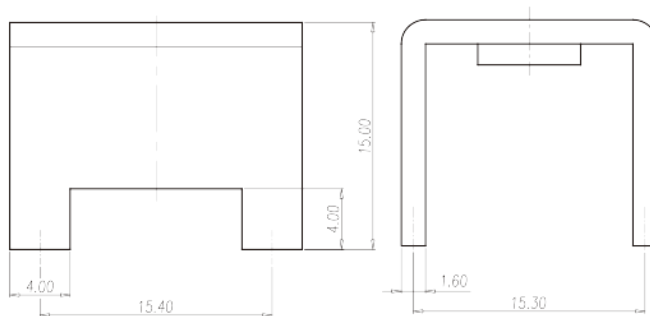
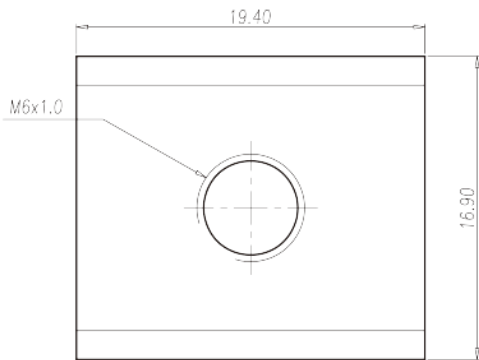

认证

