

DKZ16

DIN Rail Terminal Blocks > Busbar Terminal Blocks

Date:2026-07-04Version:1.1

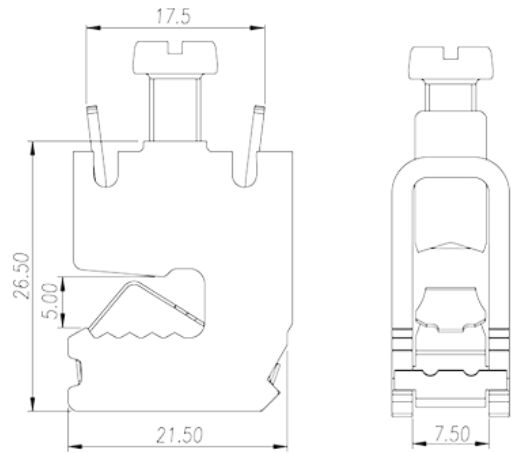

The web catalog is for reference only. Dinkle remains the right of product modification and engineering change of the design. The final product is made according to engineering drawing.

Product Description

M5, Steel

General information

Short description	DIN Rail terminal blocks, Busbar terminal blocks
Connection method	Screw connection
Type of locking	Busbar mounting
Connection points	1

Connection data-IEC

Conductor cross section solid. min (mm ²)	1.5
Conductor cross section solid.max (mm ²)	16
Conductor cross section stranded. min (mm ²)	1.5
Conductor cross section stranded. max (mm ²)	16
Screw thread	M5
Slotted screwdriver size (Blade thickness x Width)(mm)	1.0x5.5
Philips screwdriver size	PH2
Recommend tightening torque. min (N.m)	2
Recommend tightening torque. max (N.m)	4
End cover plate required	NO

Grounding connections	NO
-----------------------	----

Connection data-UL

Min. solid wire connection (AWG) acc. to UL/CUL	14
Max. solid wire connection AWG acc. to UL/CUL	4
Min. stranded wire connection AWG acc. to UL/CUL	14
Max. stranded wire connection AWG acc. to UL/CUL	4

Environment & Safety

Back of the hand protection (YES or NO)	NO
Finger protection (YES or NO)	NO

UL Recognized

Wire Range (Group B)(AWG)	14~4
---------------------------	------

CUL Recognized

Wire Range (Group B)(AWG)	14~4
---------------------------	------

Drawings

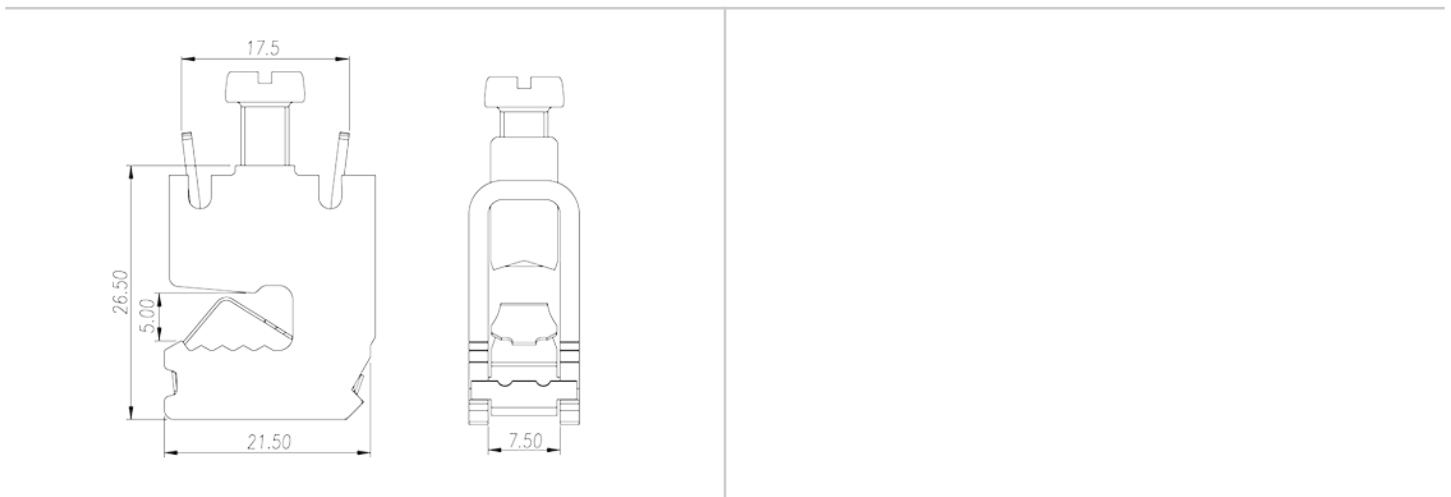

Approvals



