

DK35H

DIN Rail Terminal Blocks > Screw Connection

Date:2026-05-09Version:1.2

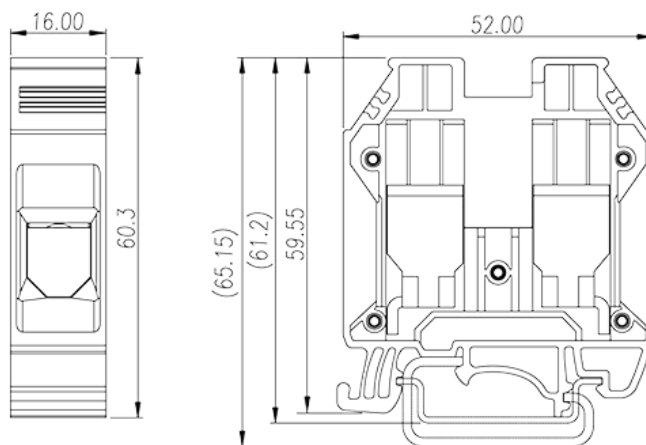
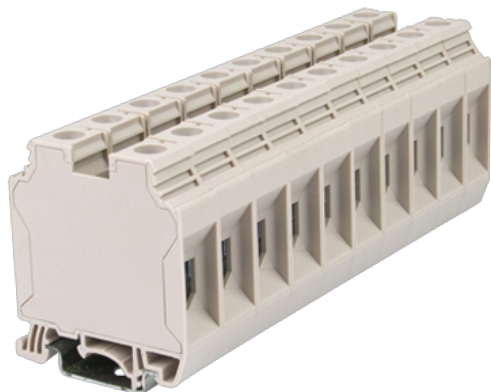

The web catalog is for reference only. Dinkle remains the right of product modification and engineering change of the design. The final product is made according to engineering drawing.

Product Description

M6, 600V, 150A, Beige (default)

General information

Short description	DIN rail terminal blocks, Feed through terminal blocks
Category	Feed through terminal blocks
Color	Beige (default)
Connection method	Screw connection
Type of locking	Rail mounting
Length (mm)	53
Width (mm)	16
Height (mm)	60.3
Number of positions	□1P
Level	Single level
Connection points	2

Material information

Insulation material	PA
Insulation material group	I
Flame retardant rating , compliant with UL94	V0

Insulation resistance

 $\geq 500\text{M}\Omega$ at DC 500V

Connection data-IEC

Rated voltage (V)	1000
Rated current (A)	150
Rated voltage (III/3)(V)	1000
Rated impulse voltage (II/2)(KV)	8
Rated impulse voltage (III/2)(KV)	8
Rated impulse voltage (III/3)(KV)	8
Conductor cross section solid. min (mm ²)	2.5
Conductor cross section solid.max (mm ²)	50
Conductor cross section stranded. min (mm ²)	2.5
Conductor cross section stranded. max (mm ²)	50
Conductor cross section flexible, with min ferrule without plastic sleeve (mm ²)	2.5
Conductor cross section flexible, with max ferrule without plastic sleeve (mm ²)	35
Conductor cross section flexible, with min ferrule with plastic sleeve (mm ²)	2.5
Conductor cross section flexible, with max ferrule with plastic sleeve (mm ²)	35
2 conductors with same cross section, solid, min (mm ²)	2.5
2 conductors with same cross section, solid, max (mm ²)	16
2 conductors with same cross section, stranded, min (mm ²)	2.5
2 conductors with same cross section, stranded, max (mm ²)	10
2 conductors with same cross section flexible, with min ferrule without plastic sleeve (mm ²)	2.5
2 conductors with same cross section flexible, with max ferrule without plastic sleeve (mm ²)	10
2 conductors with same cross section flexible, min twin ferrules with plastic sleeve (mm ²)	2.5
2 conductors with same cross section flexible, max twin ferrules with plastic sleeve (mm ²)	10
Screw thread	M6
Slotted screwdriver size (Blade thickness x Width)(mm)	1.0x5.5
Rated torque (N.m)	3.5~6.9
Recommend tightening torque. min (N.m)	3.5

Recommend tightening torque. max (N.m)	6.9
Stripping Length (mm)	16~18
Mounting rail	TS-35
End cover plate required	NO
Grounding connections	NO

Connection data-UL

Rated voltage (UL/CUL Group B)(V)	600
Rated current (UL/CUL Group B)(A)	150
Rated voltage (UL/CUL Group C)(V)	600
Rated current (UL/CUL Group C)(A)	150
Min. solid wire connection (AWG) acc. to UL/CUL	12
Max. solid wire connection AWG acc. to UL/CUL	1/0
Min. stranded wire connection AWG acc. to UL/CUL	12
Max. stranded wire connection AWG acc. to UL/CUL	1/0

Environment & Safety

Back of the hand protection (YES or NO)	YES
Finger protection (YES or NO)	YES
Operating temperature. max (°C)	120
Operating temperature. min (°C)	-40

UL Recognized

Wire Range (Group B)(AWG)	12~1/0
Rated voltage (Group B)(V)	600
Rated current (Group B)(A)	150
Wire Range (Group C)(AWG)	12~1/0
Rated voltage (Group C)(V)	600
Rated current (Group C)(A)	150

CUL Recognized

Wire Range (Group B)(AWG)	12~1/0
Rated voltage (Group B)(V)	600
Rated current (Group B)(A)	150
Wire Range (Group C)(AWG)	12~1/0

Rated voltage (Group C)(V)	600
Rated current (Group C)(A)	150

VDE Approval

Wire Range (mm ²)	2.5~50
Rated voltage (V)	1000
Rated current (A)	150

Drawings

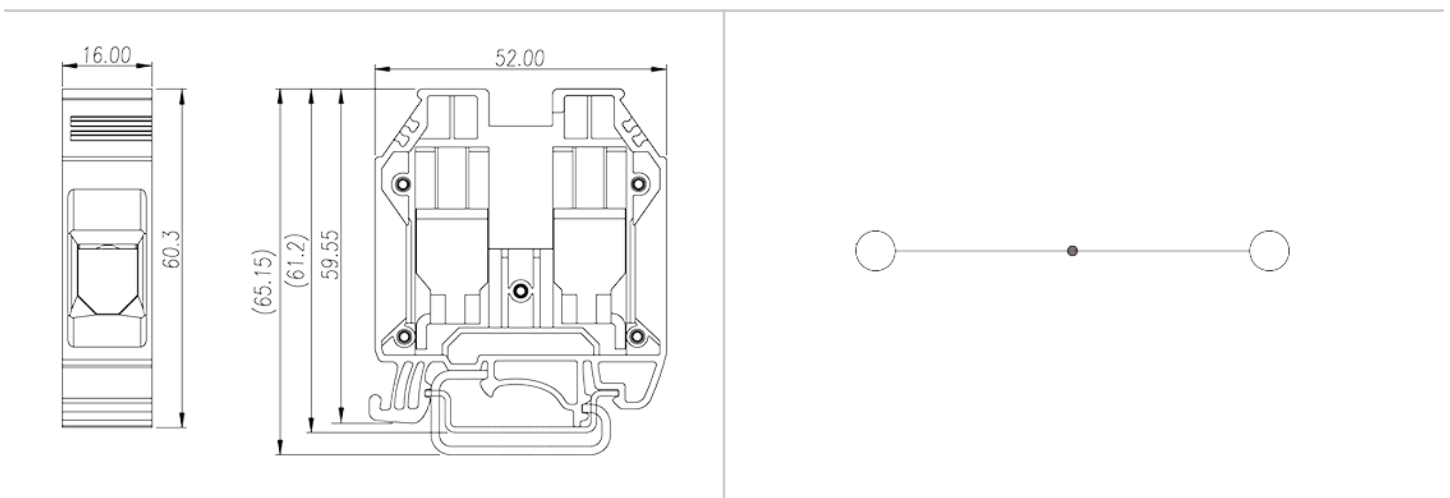

Approvals

