

# DKZ70B

DIN Rail Terminal Blocks &gt; Busbar Terminal Blocks

Date:2026-07-04Version:1.1

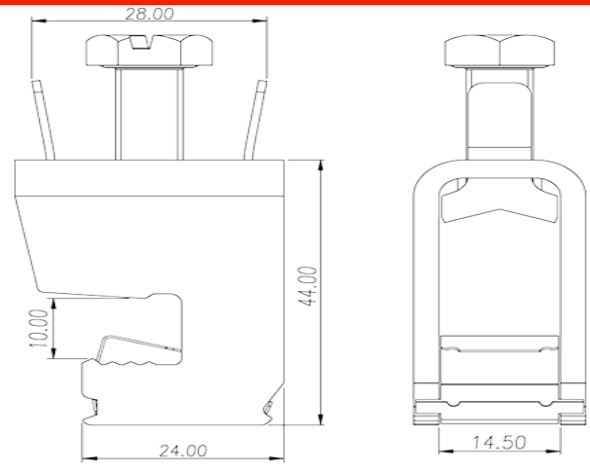

The web catalog is for reference only. Dinkle remains the right of product modification and engineering change of the design. The final product is made according to engineering drawing.

## Product Description

M8, Steel

## General information

Short description	DIN Rail terminal blocks, Busbar terminal blocks
Connection method	Screw connection
Type of locking	Busbar mounting
Connection points	1

## Connection data-IEC

Conductor cross section solid. min (mm <sup>2</sup> )	16
Conductor cross section solid.max (mm <sup>2</sup> )	70
Conductor cross section stranded. min (mm <sup>2</sup> )	16
Conductor cross section stranded. max (mm <sup>2</sup> )	70
Screw thread	M8
Slotted screwdriver size (Blade thickness x Width)(mm)	1.0x5.5
Philips screwdriver size	PH3
Rated torque (N.m)	10
End cover plate required	NO
Grounding connections	NO

## Connection data-UL

Min. solid wire connection (AWG) acc. to UL/CUL	4
Max. solid wire connection AWG acc. to UL/CUL	2/0
Min. stranded wire connection AWG acc. to UL/CUL	4
Max. stranded wire connection AWG acc. to UL/CUL	2/0

## Environment & Safety

Back of the hand protection (YES or NO)	NO
Finger protection (YES or NO)	NO

## UL Recognized

Wire Range (Group B)(AWG)	4~2/0
---------------------------	-------

## CUL Recognized

Wire Range (Group B)(AWG)	4~2/0
---------------------------	-------

## Drawings



## Approvals



