

DKZ4E-YG

DIN Rail Terminal Blocks > Busbar Terminal Blocks

Date:2026-05-09Version:1.1

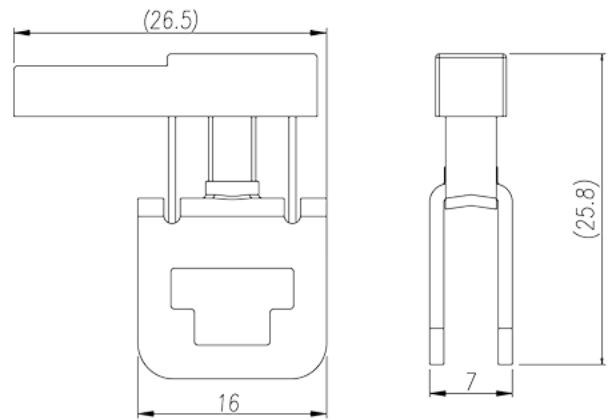
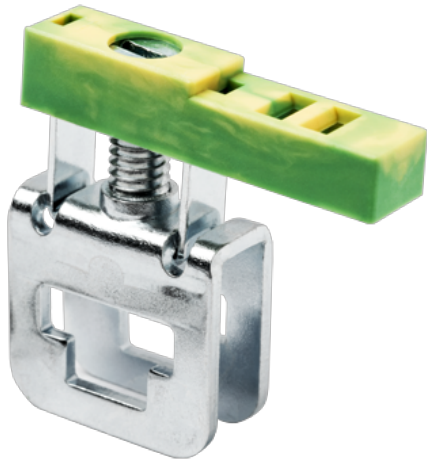

The web catalog is for reference only. Dinkle remains the right of product modification and engineering change of the design. The final product is made according to engineering drawing.

Product Description

M4, Steel

General information

Short description	DIN Rail terminal blocks, Busbar terminal blocks
Color	Green-Yellow (default)
Connection method	Screw connection
Type of locking	Busbar mounting
Connection points	1

Material information

Insulation material	PA
Insulation material group	I
Flame retardant rating , compliant with UL94	V2

Connection data-IEC

Conductor cross section solid. min (mm ²)	0.5
Conductor cross section solid.max (mm ²)	6
Conductor cross section stranded. min (mm ²)	0.5
Conductor cross section stranded. max (mm ²)	6

Screw thread	M4
Slotted screwdriver size (Blade thickness x Width)(mm)	1.0x5.5
Philips screwdriver size	PH2
Recommend tightening torque. min (N.m)	1.2
Recommend tightening torque. max (N.m)	2.4
End cover plate required	NO
Grounding connections	NO

Connection data-UL

Min. solid wire connection (AWG) acc. to UL/CUL	20
Max. solid wire connection AWG acc. to UL/CUL	10
Min. stranded wire connection AWG acc. to UL/CUL	20
Max. stranded wire connection AWG acc. to UL/CUL	10

Environment & Safety

Back of the hand protection (YES or NO)	NO
Finger protection (YES or NO)	NO

Drawings

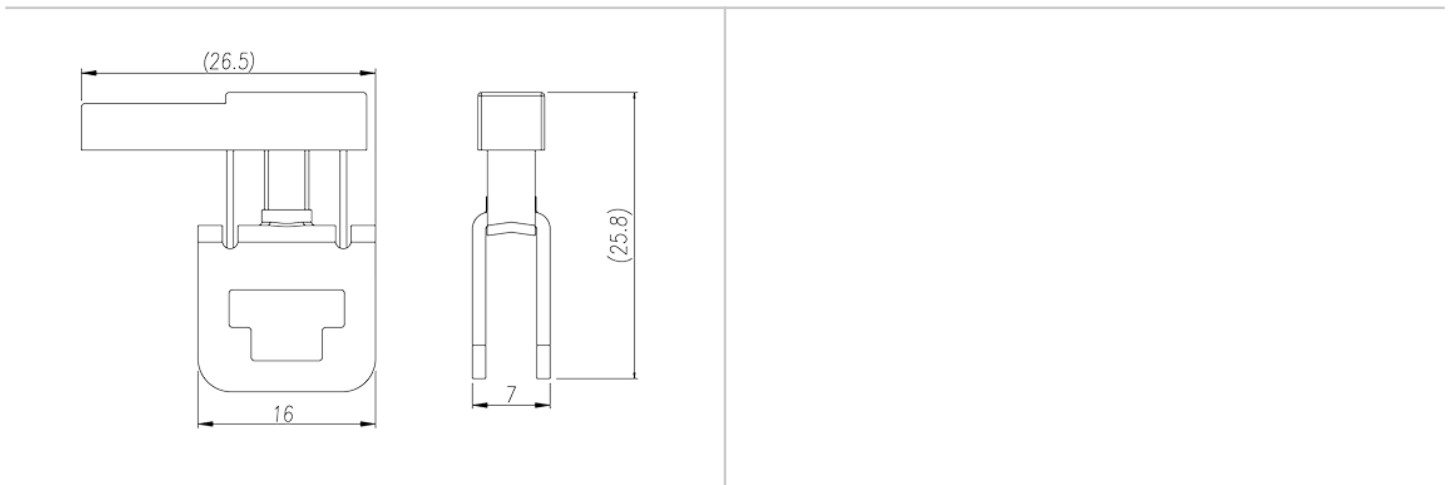

Approvals



