

# WKV750A-XXP

PCB Terminal Blocks > PCB Terminal Blocks

Date:2026-05-09Version:V1

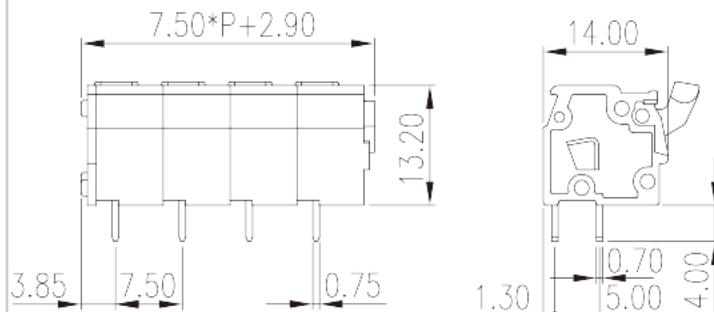
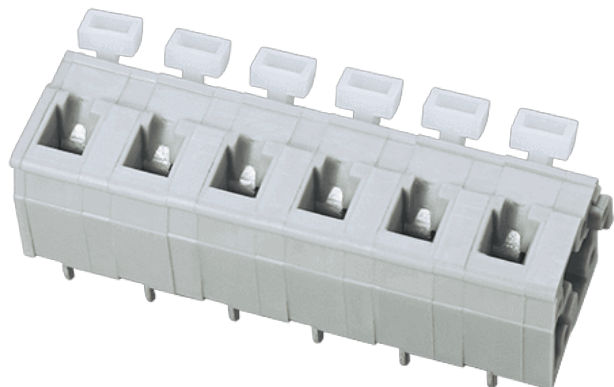

The web catalog is for reference only. Dinkle remains the right of product modification and engineering change of the design. The final product is made according to engineering drawing.

## Product Description

Pitch : 7.50mm, 300V, 15A

## General information

Short description	PCB Terminal Blocks, Spring clamp connection
Category	PCB Terminal Blocks
Pitch (mm)	7.5
Color	Grey (default)
Connection method	Spring clamp connection
Type of locking	Without
Length (mm)	7.50*P+2.90
Width (mm)	13
Height (mm)	13.2
Pin demensions (Thickness x Width)(mm)	0.7x0.75
PCB hole diameter (mm)	1.1~1.2
Number of positions	02P~24P
Level	Single level

## Material information

Insulation material	PA
---------------------	----

Insulation material group	I
Flame retardant rating , compliant with UL94	V0
Insulation resistance	□500MΩ at DC 500V
Conductor material	COPPER ALLOY
Plating of conductor surface	Tin PLATED

## Connection data-IEC

Rated voltage (V)	450
Rated current (A)	24
Rated voltage (II/2)(V)	1000
Rated voltage (III/2) (V)	630
Rated voltage (III/3)(V)	500
Rated impulse voltage (II/2)(KV)	6
Rated impulse voltage (III/2)(KV)	6
Rated impulse voltage (III/3)(KV)	6
Conductor cross section solid. min (mm <sup>2</sup> )	0.5
Conductor cross section solid.max (mm <sup>2</sup> )	2.5
Conductor cross section stranded. min (mm <sup>2</sup> )	0.5
Conductor cross section stranded. max (mm <sup>2</sup> )	2.5
Conductor cross section flexible, with min ferrule without plastic sleeve (mm <sup>2</sup> )	0.25
Conductor cross section flexible, with max ferrule without plastic sleeve (mm <sup>2</sup> )	1.5
Conductor cross section flexible, with min ferrule with plastic sleeve (mm <sup>2</sup> )	0.25
Conductor cross section flexible, with max ferrule with plastic sleeve (mm <sup>2</sup> )	1.5
Stripping Length (mm)	5~6

## Connection data-UL

Rated voltage (UL/CUL Group B)(V)	300
Rated current (UL/CUL Group B)(A)	15
Rated voltage (UL/CUL Group C)(V)	150
Rated current (UL/CUL Group C)(A)	15
Rated voltage (UL/CUL Group D)(V)	300
Rated current (UL/CUL Group D)(A)	10
Min. solid wire connection (AWG) acc. to UL/CUL	28

Max. solid wire connection AWG acc. to UL/CUL	12
Min. stranded wire connection AWG acc. to UL/CUL	28
Max. stranded wire connection AWG acc. to UL/CUL	12

## Environment & Safety

Finger protection (YES or NO)	YES
Operating temperature. max (°C)	120
Operating temperature. min (°C)	-40

## UL Recognized

Wire Range (Group B)(AWG)	28~12
Rated voltage (Group B)(V)	300
Rated current (Group B)(A)	15
Wire Range (Group C)(AWG)	28~12
Rated voltage (Group C)(V)	150
Rated current (Group C)(A)	15
Wire Range (Group D)(AWG)	28~12
Rated voltage (Group D)(V)	300
Rated current (Group D)(A)	10

## CUL Recognized

Wire Range (Group B)(AWG)	28~12
Rated voltage (Group B)(V)	300
Rated current (Group B)(A)	15
Wire Range (Group C)(AWG)	28~12
Rated voltage (Group C)(V)	150
Rated current (Group C)(A)	15
Wire Range (Group D)(AWG)	28~12
Rated voltage (Group D)(V)	150
Rated current (Group D)(A)	10

## VDE Approval

Wire Range (mm <sup>2</sup> )	0.5~2.5
Rated voltage (V)	450
Rated current (A)	24

## Drawings

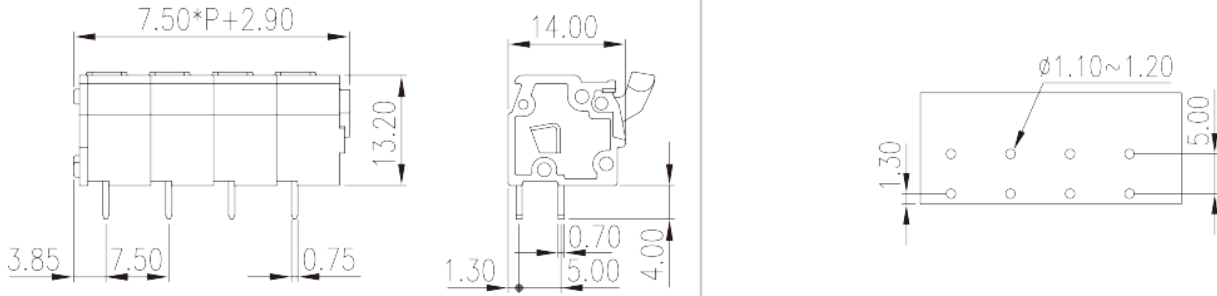

## Approvals

