

# 5EHDRRC-XXPL

PCB Terminal Blocks &gt; PCB Connector-Socket

Date:2026-07-04Version:V1

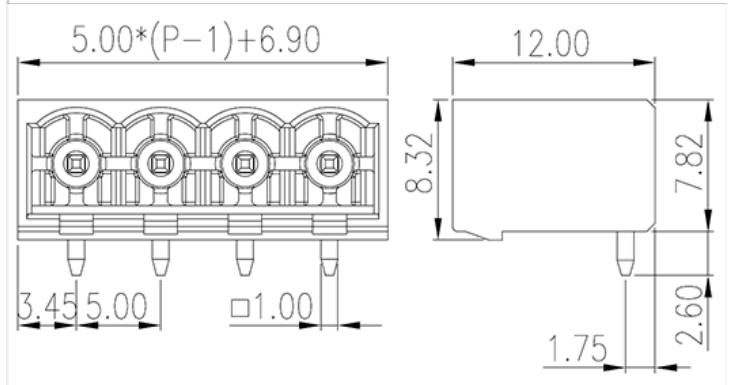
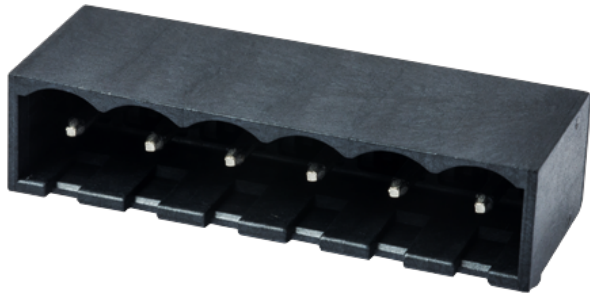

The web catalog is for reference only. Dinkle remains the right of product modification and engineering change of the design. The final product is made according to engineering drawing.

## Product Description

Pitch : 5.00 mm, 300V, 15A

## General information

Short description	PCB Connector – Socket, Reflow Soldering
Category	PCB Connector – Socket
Pitch (mm)	5.00
Color	Black (default)
Type of locking	Without
Soldering method	Reflow Soldering (Temperature condition according to standard IPC/JEDEC J-STD-020E)
Length (mm)	$5.00*(P-1)+6.9$
Width (mm)	12
Height (mm)	8.32
Pin demensions (Thickness x Width)(mm)	1.0x1.0
PCB hole diameter (mm)	1.6~1.7
Number of positions	02P~24P
Level	Single level

## Material information

Insulation material	HIGH-TEMPERATURE PLASTICS
Insulation material group	IIIa
Flame retardant rating , compliant with UL94	V0
Insulation resistance	□500MΩ at DC 500V
Conductor material	COPPER ALLOY
Plating of conductor surface	Tin PLATED
MSL	1

## Connection data-IEC

Rated voltage (V)	600
Rated current (A)	18
Rated voltage (II/2)(V)	600
Rated voltage (III/2) (V)	400
Rated voltage (III/3)(V)	320
Rated impulse voltage (II/2)(KV)	4
Rated impulse voltage (III/2)(KV)	4
Rated impulse voltage (III/3)(KV)	4

## Connection data-UL

Rated voltage (UL/CUL Group B)(V)	300
Rated current (UL/CUL Group B)(A)	15
Rated voltage (UL/CUL Group D)(V)	300
Rated current (UL/CUL Group D)(A)	15

## Environment & Safety

Finger protection (YES or NO)	YES
Operating temperature. max (°C)	120
Operating temperature. min (°C)	-40

## UL Recognized

Rated voltage (Group B)(V)	300
Rated current (Group B)(A)	15
Rated voltage (Group D)(V)	300
Rated current (Group D)(A)	15

## CUL Recognized

Rated voltage (Group B)(V)	300
Rated current (Group B)(A)	15
Rated voltage (Group D)(V)	300
Rated current (Group D)(A)	15

## Drawings

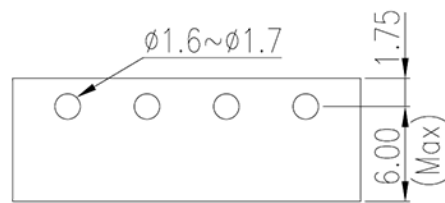
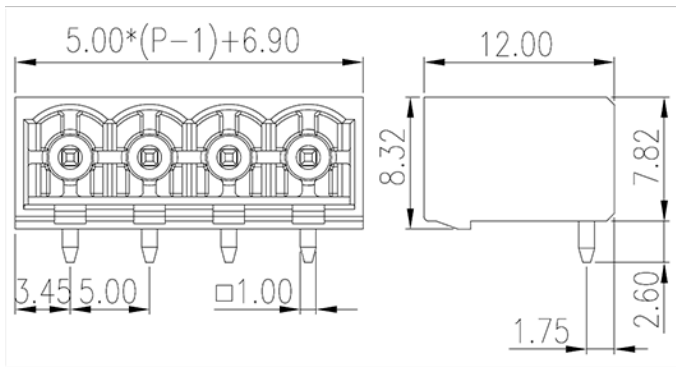

## Approvals

