

# 0188-01XXL

PCB Terminal Blocks &gt; PCB Terminal Blocks

Date:2026-05-09

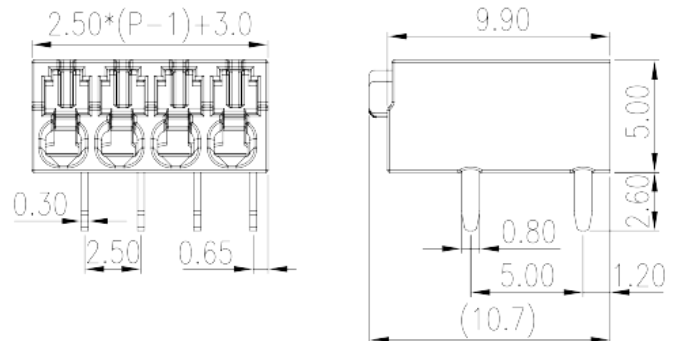

The web catalog is for reference only. Dinkle remains the right of product modification and engineering change of the design. The final product is made according to engineering drawing.

## Product Description

Pitch : 2.50mm, 150V, 5A

## General information

Short description	PCB Terminal Blocks, Push-in Design
Category	PCB Terminal Blocks
Pitch (mm)	2.50
Color	Black (default)
Connection method	Push in design
Type of locking	Without
Soldering method	Reflow Soldering (Temperature condition according to standard IPC/JEDEC J-STD-020E)
Length (mm)	$2.50*(P-1)+3.0$
Width (mm)	10.7
Height (mm)	5
Pin demensions (Thickness x Width)(mm)	0.3x0.8
PCB hole diameter (mm)	1.2
Number of positions	02P~20P
Level	Single level

## Material information

Insulation material	HIGH-TEMPERATURE PLASTICS
Insulation material group	I
Flame retardant rating , compliant with UL94	V0
Insulation resistance	□500MΩ at DC 500V
Conductor material	COPPER ALLOY
Plating of conductor surface	Tin PLATED
MSL	2

## Connection data-IEC

Rated voltage (V)	160
Rated current (A)	6
Rated voltage (II/2)(V)	400
Rated voltage (III/2) (V)	160
Rated voltage (III/3)(V)	160
Rated impulse voltage (II/2)(KV)	2.5
Rated impulse voltage (III/2)(KV)	2.5
Rated impulse voltage (III/3)(KV)	2.5
Conductor cross section solid. min (mm <sup>2</sup> )	0.2
Conductor cross section solid.max (mm <sup>2</sup> )	0.5
Conductor cross section stranded. min (mm <sup>2</sup> )	0.2
Conductor cross section stranded. max (mm <sup>2</sup> )	0.5
Conductor cross section flexible, with min ferrule without plastic sleeve (mm <sup>2</sup> )	0.25
Conductor cross section flexible, with max ferrule without plastic sleeve (mm <sup>2</sup> )	0.5
Stripping Length (mm)	7~8

## Connection data-UL

Rated voltage (UL/CUL Group B)(V)	150
Rated current (UL/CUL Group B)(A)	5
Min. solid wire connection (AWG) acc. to UL/CUL	26
Max. solid wire connection AWG acc. to UL/CUL	18
Min. stranded wire connection AWG acc. to UL/CUL	26
Max. stranded wire connection AWG acc. to UL/CUL	18

## Environment & Safety

Finger protection (YES or NO)	YES
Operating temperature. max (°C)	120
Operating temperature. min (°C)	-40

### UL Recognized

Wire Range (Group B)(AWG)	26~18
Rated voltage (Group B)(V)	150
Rated current (Group B)(A)	5

### CUL Recognized

Wire Range (Group B)(AWG)	26~18
Rated voltage (Group B)(V)	150
Rated current (Group B)(A)	5

### Drawings

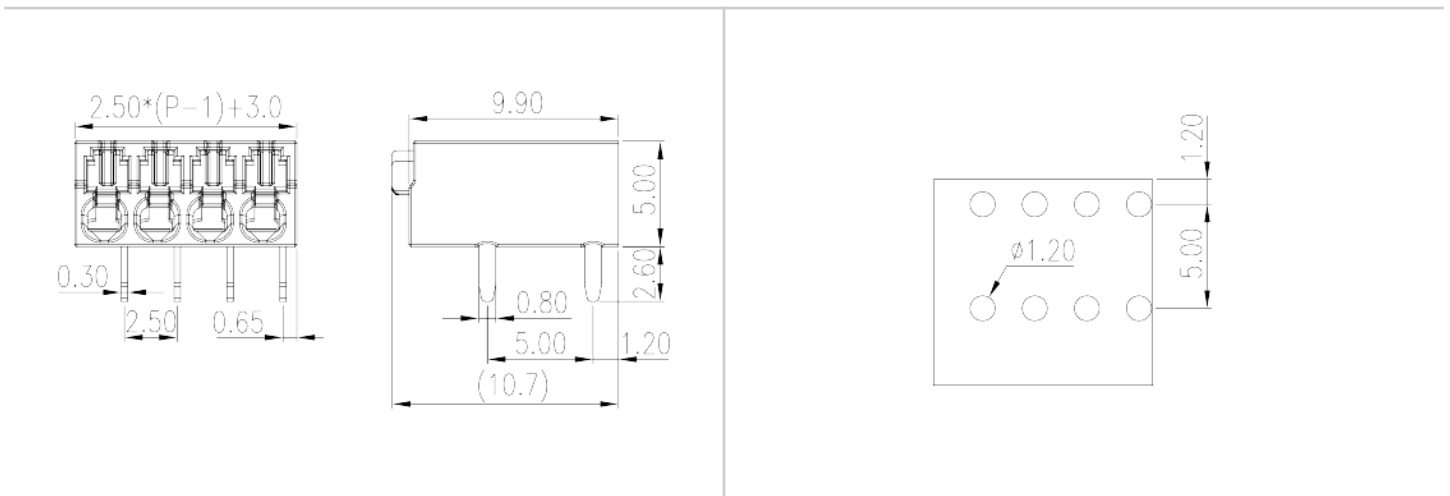

### Approvals

